



CURIOUS SCIENTIFIC INVESTIGATORS:

# Flight adventures

**A Unit of Study for Grades 3-5**



## Acknowledgements

CURIOUS SCIENTIFIC INVESTIGATORS:

# Flight adventures

A Unit of Study for Grades 3–5



### Author and Senior Editor

Rick Crosslin, The Children's Museum of Indianapolis  
Gordon Schimmel, Ed.D., Academy of Model Aeronautics

### Readers

Lynn Bondurant, Ph.D., retired NASA educator  
Michael Smith, Museum Director, Academy of Model Aeronautics  
Camille Warren, The Children's Museum of Indianapolis

### Special Thanks to:

#### National Aeronautics and Space Administration

Tony Springer, Lead for Communications and Education in Aeronautics, NASA  
Jenay Sharpe Leach, Albert Einstein Distinguished Educator Fellow, NASA; Aeronautics Research Mission Directorate

#### Academy of Model Aeronautics (AMA)

Michael Smith, Museum Director  
Bill Pritchett, Director of Education  
Gordon Schimmel, Education Program Development  
Jack Frost, Academy of Model Aeronautics  
Arthur Ellis, educator; former curator at Eli Whitney Museum, Hamden, CT

#### Dryden Flight Research Center, NASA (DFRC)

Russ Claugton, Director of Education  
Kevin Rohrer, Acting Director of Strategic Communications  
Steve Lighthill, Creative, Director of Communications  
Mary Ann Harness, Public Outreach Specialist, Tybrin Co.  
Leslie Williams, Public Affairs Specialist  
Christian Gelzer, Historian  
Leslie Monforton, Associate Engineer, 3/OE-DROID/AGCAS Model Shop  
Brad Neal, Deputy Chief Engineer of Projects  
Cecilia Cordova, NASA Dryden, Informal Education Manager, First Robotics Coordinator

**The Children's Museum of Indianapolis** is a nonprofit institution dedicated to providing extraordinary learning experiences across the arts, sciences, and humanities that have the power to transform the lives of children and families. It is the largest children's museum in the world and serves more than 1 million people across Indiana as well as visitors from other states and nations. The museum provides special programs and experiences for students as well as teaching materials and professional development opportunities for teachers. To plan a visit or learn more about educational programs and resources, visit the Teacher section of the museum's website, [childrensmuseum.org/teachers](http://childrensmuseum.org/teachers)

### National Aeronautics and Space Administration

Based upon work supported by NASA under grant award Number NNX10AK16G. Any opinions, findings, and conclusions or recommendations expressed in this material are those of the author(s) and do not necessarily reflect the views of the National Aeronautics and Space Administration.

### Unit of Study Field-Test Teachers

Michelle Baxter, North Elementary School, Washington, IN  
Debra Carr, Torrence Creek Elementary School, Huntersville, NC  
Tracy Havens, Southwest Elementary School, Greenwood, IN  
Andra Hirsch, St. Bartholomew School, Columbus, IN  
Alicia Madeka, Kenwood Elementary School, Hammond, IN  
Jamil Odom, Mary Bryan Elementary School, Indianapolis, IN  
Cathleen Schwartz, Charles W. Fairbanks School, IPS #105, Indianapolis, IN  
Nicole Scott, Stephen Foster School, IPS #67, Indianapolis, IN

CURIOUS SCIENTIFIC INVESTIGATORS:

# Flight adventures

A Unit of Study for Grades 3–5



## The Space Shuttle Comes Home

The space shuttle is the result of flight and aeronautical research. It returns to Earth as an unpowered glider through the atmosphere.

PHOTO COURTESY OF NASA

<b>Introduction</b> .....	4
<b>About NASA</b> .....	5
<b>What's Ahead</b> .....	6
<b>What Will Students Learn?</b> .....	7
<b>Getting Started: Teacher Tips</b> .....	8
<b>Lesson 1 — Moving Through the Air: Weight and Lift</b> .....	10
Experience 1: Leonardo da Vinci Parachute Model .....	11
Experience 2: Indoor Paper Box Kite Model .....	21
<b>Lesson 2 — Moving Through the Air: Thrust and Drag</b> .....	32
Experience 1: Paper Rocket Model .....	34
<b>Lesson 3 — Moving Through the Air: Control</b> .....	42
Experience 1: FPG-9 Glider Model .....	44
<b>Culminating Experience and Assessment</b>	
Design, Build, Test, and Fly a Model .....	51
Extending the Experience: Jetstream Tethered Model .....	54
<b>Resources</b>	
CSI Flight Adventures at the Museum .....	61
Website Links .....	61
Academy of Model Aeronautics .....	62
Glossary of Key Terms .....	63
Academic Standards .....	64

## Introduction

### Vision Statement

Many students know that the Wright brothers were curious science investigators who explored flight. Like other early pioneers of aviation, Orville and Wilbur overcame many obstacles to master modern flight. Few students, however, know the role that model aircraft have played in addressing aviation challenges. Throughout aviation history and to the present day, model airplanes have been and continue to be used as proof-of-concept vehicles in full-scale aircraft design. Modeling is essential to math, science, and engineering—in fact, to all creative thinking. The model is a metaphor—a way of understanding cause and effect, a context, and an outcome. Through the NASA Curious Scientific Investigators (CSI): Flight Adventures project, SpaceQuest® Planetarium multimedia show, and accompanying unit of study, students will learn that aircraft models are tools we use to explore the science of flight. Flight once was an unattainable dream. Through the CSI Flight Adventures experiences students will become aviators by building, testing, modifying, repairing, and flying model aircraft.

### Students will learn that

- science, technology, engineering, and math help us understand how flight works;
- early pioneers of flight used models to advance aviation;
- free-flight models are tools used to test ideas and solve problems to improve flight performance;
- NASA uses models to test new ideas and solve existing problems, improving flight technology, safety, and performance;
- NASA employs a variety of staff with diverse skills; and
- aviators make, test, repair, and fly model aircraft.

### Enduring Idea

Models are tools we use to explore the science of flight.

### Overview

Through this unit of study, students will be introduced to three main project concepts:

- how models have been used in the history of aviation to solve problems;
- how NASA uses models to test new ideas and solve existing problems, improving flight technology, safety, and performance; and
- how models can demonstrate the properties of flight to children and families.

### Academic Standards

Lessons in this unit of study are aligned to state and national academic standards in science, language arts, and mathematics. Each lesson features one aspect of how models are used in flight. The experiences focus on background information about flight and hands-on science experiences using models. Students will be introduced to the ways model aircraft have been used to solve past, present, and future challenges in aviation. Students will discuss the history of aviation and the role that models have played in NASA aerospace research. They will learn about specific NASA aeronautics careers and opportunities. Students will design, build, test, fly, and revise model aircraft to explore ideas about flight.



### Wright Brothers First Flight

On December 17, 1903, two brothers from Dayton, Ohio, named Wilbur and Orville Wright, were successful in flying an airplane they built. Their powered aircraft flew for 12 seconds above the sand dunes of Kitty Hawk, North Carolina, making them the first men to pilot a heavier-than-air machine that took off on its own power, remained under control, and sustained flight.

PHOTO COURTESY OF NASA

## About NASA's Education Program

[nasa.gov/offices/education/about/index.html](http://nasa.gov/offices/education/about/index.html)

NASA's journeys into air and space have deepened humanity's understanding of the universe, catalyzed technology breakthroughs, enhanced air travel safety and security, and expanded the frontiers of scientific research. These accomplishments share a common genesis: education. As the United States begins its second century of flight, the nation must maintain its commitment to excellence in science, technology, engineering, and mathematics education to ensure that the next generation of Americans can accept the full measure of their roles and responsibilities in shaping the future. NASA will continue the agency's tradition of investing in the nation's education programs and supporting the country's educators, who play a key role in preparing, inspiring, exciting, encouraging, and nurturing young people today who will be the workforce of tomorrow.

### NASA will continue to pursue three major education goals:

- Strengthening NASA and the nation's future workforce
- Attracting and retaining students in science, technology, engineering, and mathematics (STEM) disciplines
- Engaging Americans in NASA's mission



Students from Ferebee-Hope Elementary School in Washington, D.C., take turns trying on a glove from a space suit on Tuesday, Feb. 8, 2011. Ferebee-Hope Elementary School, in collaboration with Reading Is Fundamental, hosted this event in honor of Black History Month, and to highlight the importance of reading. NASA Associate Administrator for Education and STS-129 astronaut Leland Melvin read to first- and third-grade students at the school from the book *The Moon Over Star* during the event.

IMAGE CREDIT: NASA/CARLA CIOFFI



The X-48B Blended Wing Body research aircraft banks smartly during its Block 2 flight phase.

NASA PHOTO / CARLA THOMAS

### NASA Aeronautics Education

Fostering new generations of highly skilled scientists and engineers is critically important to the aeronautics community. The Aeronautics Research Mission Directorate (ARMD), as part of its commitment to mastering the core competencies of aeronautics in all flight regimes, is restructuring its education program, including focusing investments in undergraduate and graduate education. [aeronautics.nasa.gov/education.html](http://aeronautics.nasa.gov/education.html)

### NASA Aeronautics

NASA's Aeronautics Research Mission Directorate (ARMD) works to address the challenges that still exist in our nation's air transportation system. NASA Aeronautics has made decades of contributions to aviation. Nearly every aircraft today has a NASA-supported technology on board that helps the vehicle fly more safely and efficiently. Aeronautics research takes place at four NASA Centers: NASA Ames Research Center, NASA Dryden Flight Research Center, NASA Glenn Research Center, and NASA Langley Research Center. [nasa.gov/topics/aeronautics/index.html](http://nasa.gov/topics/aeronautics/index.html)

### NASA Aeronautics E-Books

Many of the biggest achievements in aeronautics research are chronicled in books rich with detail, personal stories, and surprising twists of fate and revolutionary discoveries that have influenced the experience of flight for millions of people. [aeronautics.nasa.gov/ebooks/index.html](http://aeronautics.nasa.gov/ebooks/index.html)

## Introduction

### What's Ahead

Students will construct and use models in the following lessons and experiences to investigate the science of flight.

#### Lesson 1: Weight and Lift

Students will learn that air is made of matter. Using a model, students investigate various factors, including weight and surface area, that affect how objects move through air. Students learn how moving air causes a kite to fly.

#### Lesson 2: Thrust and Drag

Students construct a rocket using paper, pencil, and tape, and use it to investigate thrust and drag.

#### Lesson 3: Control

Students build and fly an FPG-9 (Foam Plate Glider 9-inch) model to investigate how to control a model plane in flight by manipulating various control surfaces. Using the FPG-9 model, students observe the three dynamics of flight (ways a plane can move): pitch, roll, and yaw.

#### Culminating Experience and Assessment: Design, Build, Test, and Fly a Model

Students apply what they have learned to select a Flight Challenge and design, build, and test their model to accomplish it. The model should demonstrate concepts learned in the unit of study and be connected to a NASA project.

#### Extending the Experience: Jetstream Tethered Model

Teachers construct a rubber-band-powered model to demonstrate how weight and drag affect flight.

### NASA Online Resources

Teachers and students can access extraordinary online resources at the NASA website. Specific web pages are identified for each lesson in the unit of study. The resources are presented for students and educators. More resources are located on pages 61–62.



### NASA for Students

[nasa.gov/audience/forstudents/index.html](http://nasa.gov/audience/forstudents/index.html)

### NASA for Educators

[nasa.gov/audience/foreducators/index.html](http://nasa.gov/audience/foreducators/index.html)

### NASA Central Operation of Resources for Educators (CORE)

<http://core.nasa.gov>

The Central Operation of Resources for Educators, established in cooperation with Lorain County Joint Vocational School, serves as the worldwide distribution center for NASA-produced multimedia materials. For a minimal charge, CORE will provide a valuable service to educators unable to visit one of the NASA Educator Resource Centers by making NASA educational materials available through its mail-order service.

### NASA Beginner's Guide to Aeronautics

[www.grc.nasa.gov/WWW/K-12/airplane/index.html](http://www.grc.nasa.gov/WWW/K-12/airplane/index.html)

### Online Support

The Children's Museum of Indianapolis CSI Flight Adventures:

[childrensmuseum.org/flightadventures](http://childrensmuseum.org/flightadventures)

This unit of study has an online video component suitable both for teacher background information and viewing by students. The lessons are designed to be complete as written. However, it is highly recommended that teachers preview the video segments before class and then use them in the presentation of each lesson.

### CSI-Flight Videos include:

- Introduction; Paper Ball Demonstration; Building and Flying the Leonardo da Vinci Parachute
- Building and Flying a Paper Box Kite
- Building and Launching Paper Rockets
- Building, Flying, and Controlling the FPG-9 Glider, Culminating Activity
- AeroLab – Total Control, AMA
- Jetstream – Teacher Demonstration



The No. 2 X-29 technology demonstrator aircraft is seen here during a 1990 test flight. At this angle, the aircraft's unique forward-swept wing design is clearly visible.

PHOTO COURTESY OF NASA DRYDEN FLIGHT RESEARCH CENTER (NASA-DFRC)

## What Will Students Learn?

CSI: Flight Adventure Unit of Study Target Content	Lesson 1		Lesson 2	Lesson 3
	1	2	1	1
Experience	1	2	1	1
<b>Target Ideas</b>				
Air is matter. It takes up space and has mass.	★	★	★	★
A force pushes or pulls on an object.	★	★	★	★
Earth's gravity is the force that pulls an object toward the Earth.		★		
Weight is the force an object has due to gravity.		★	★	★
Drag is the force that opposes the motion of an object.	★	★	★	★
Thrust is a force that propels an object in a specific direction.			★	★
Lift is a force that directly opposes the weight of a moving object and holds it up. An object in flight is lifted when air moves past it.		★	★	★
Pushing or pulling forces can change the position and motion of objects. The amount of change in the motion of an object is related to the strength of the push or pull acting on it.	★	★	★	★
Models are tools used for learning and communicating ideas about flight.	★	★	★	★

★ Students will understand the entire idea from information presented in the experience. ★ Students will be introduced to part of the idea or will apply the idea.

## Introduction



ROBERT "HOOT" GIBSON: Ambassador—Academy of Model Aeronautics, NASA Space Shuttle Commander, Astronaut Hall of Fame Member, Naval Aviator

© ALL RIGHTS RESERVED BY THE ACADEMY OF MODEL AERONAUTICS

## Getting Started: Teacher Tips

### Challenges of Flight: Investigation with Models

In each experience students will construct and fly a model to investigate flight challenges and the concepts that have contributed to the science of flight. Early aviation pioneers investigated and overcame challenges to flight. Through guided experiences students and teachers will investigate the same challenges. The American Association for the Advancement of Science (AAAS) project 2061 defines models as the following:

- **Model:** A representation of an object, system, or event in the real world; a model contains certain essential characteristics, but not every feature of that which is being depicted. Therefore, it is important to keep in mind how a model is different from its real world counterpart. A model may be a **physical** or **symbolic** representation.

In the assessment activity students will apply what they have learned to build, test, and fly free-flight models that demonstrate an understanding of the forces and challenges of flight.

Challenges of Flight	
<b>Challenge 1</b>	Build, test, and fly a model through air.
<b>Challenge 2</b>	Change the speed of a model moving through air.
<b>Challenge 3</b>	Control a model moving through air.
<b>Challenge 4</b>	Design, test, and fly a model through air.

You may want to make use of video cameras (flip, phone, or others) to encourage the class to record the flights of the various models they test. Students can then watch the flights in slow motion to observe movement that is not easy to see in real time.

### Forces in Flight

Physical science forces will be investigated in this unit of study so that students and teachers can understand and apply the concepts to model aircraft: **push** (lift and thrust) versus **pull** (gravity and drag). Understanding force is crucial to understanding flight. A push force creates thrust that moves an aircraft forward, and drag opposes it, slowing the forward motion. A push force creates lift that opposes the pull weight of an aircraft so that it can rise through the air for flight.

### Moving Through Air

Aeronautics is the scientific study of flight within the Earth's atmosphere. Air is made of matter. All matter takes up space and has mass. Therefore, air takes up space and has mass. Flight is possible because it occurs in air. Without air, aircraft flight is not possible. At the most basic level, forces in flight are the interaction of aircraft (matter in a solid form) and air (matter in a gas form). Types of flight not in air, such as rockets in interplanetary space (astronautics), are not part of aeronautics.

### Key Terms Development

Teachers may want to include vocabulary-building tools, such as word walls, student illustrated examples, and games, to introduce new words. Science concepts and principles are included at the end of this unit. NASA websites are included in each lesson to help build vocabulary. See the **Glossary** on page 63.

### Classroom Management

The experiences in this unit of study require students to build and construct models. Students may have little or no experience doing this. Therefore, time needed for each lesson may vary. Each lesson contains a **Stopping Point** where the lesson can be split. You should view the videos described on page 6 on your own and practice constructing the models before starting the lessons with your class. The videos show step-by-step construction of the various models used.



### Literature Connection

Many wonderful books can be used with this unit of study. One book or reading selection has been identified for each lesson. You may want to assign and have available the books listed as suggested reading for those students who finish activities early. Integrating the literature will strengthen students' understanding of the ideas.

### CSI Flight Adventure Journals

Enhance learning by allowing students to create CSI Flight Adventure science journals. Encourage students to write new vocabulary words, record observations, and make drawings of new designs. (See page 57.) The journal templates are also found at [childrensmuseum.org/flightadventures](http://childrensmuseum.org/flightadventures)

### NASA Websites

NASA websites are listed for each lesson. Educational websites are included for teachers and students. In addition, several NASA sites are noted that include news and mission information.

### NASA Careers in Aeronautics

Many exciting discoveries are being made today by the people who work at NASA. In the future, today's students will discover new technologies for passenger airplanes and fighter jets. Tomorrow's engineers and technicians will continue making improvements and modifications to existing aircraft for safer, cheaper, and more environmentally friendly flights. They also will create new types of air and space vehicles. Many different people from many different fields work together on the design process of making an aircraft. Students can meet engineers and technicians at the following websites:

### NASA Quest Challenges

[quest.nasa.gov/index.html](http://quest.nasa.gov/index.html)

### NASA Career Information

[nasa.gov/audience/forstudents/careers-index.html](http://nasa.gov/audience/forstudents/careers-index.html)

Selected NASA Dryden Flight Research Center staff are featured in career videos on this site.

### Curious Science Investigators: Flight Adventures!

[childrensmuseum.org/flightadventures](http://childrensmuseum.org/flightadventures)

### Teacher Support

[childrensmuseum.org/flightadventures](http://childrensmuseum.org/flightadventures)

This unit is designed to be a stand alone guide for teachers in Grades 3–5. However, additional materials and resources are available for teachers, including:

- Online module with step-by-step directions, videos, and resources
- Visits to The Children's Museum of Indianapolis for interactive multimedia planetarium shows, first-person interpretations, and SciencePort activities
- Professional development activities (workshops and summer institutes)
  - Public television flight documentary (online access)
- Local and national Academy of Model Aeronautics clubs and workshops
- Public television flight documentary (online access)

### Academy of Model Aeronautics

[modelaircraft.org/education](http://modelaircraft.org/education)

The Academy encourages educators to contact a local AMA club to ask for a modeler to arrange a classroom presentation and possibly an indoor or outdoor flying demonstration for the whole school. To find a club in your area, click on "Find A Club" (at the bottom right) and fill in your school's ZIP code.



While NASA Dryden's Jim Ross outlined his job as an aerial photographer, sixth-grade student Leo Banuelos learned firsthand about the gear Ross wears in the cockpit.

NASA PHOTO / TOM TSCHIDA



### The Teacher Community of Inquiry:

Share your experiences using this unit of study with your colleagues through the museum's online community dedicated exclusively to educators at [tcmteachers.org](http://tcmteachers.org). View student work and learn how to share your students' work with others. Learn about upcoming opportunities for teachers and students at the museum. Share ideas and learn what other teachers have done to enhance their students' experience at the museum. Visit [tcmteachers.org](http://tcmteachers.org) to become a part of the museum's teacher community today.

## Lesson 1: Moving Through the Air: Weight and Lift



The X-38 prototype of the Crew Return Vehicle for the International Space Station is suspended under its giant 7,500-square-foot parafoil during its eighth free flight on Thursday, Dec. 13, 2001. A portion of the descent was flown by remote control by a NASA astronaut from a ground vehicle configured like the CRV's interior before the X-38 made an autonomous landing on Rogers Dry Lake.

NASA PHOTO / TONY LANDIS

### Overview

In this lesson students learn that air is matter and discover how moving air causes a kite to fly. Using a model, students investigate how various factors, specifically weight and surface area, affect how objects move through air. Flight is possible because it occurs in air; without air, flight is not possible. Students ask questions, collect data, test ideas, record results, and draw conclusions about how objects move through air.

### Connecting to Standards

The lessons in this unit of study relate to the following Indiana Academic Standards, National Science Education Standards (NRC, 1996), and National Common Core State Standards in Language Arts and Mathematics.

#### Indiana Academic Standards

Science: 3.4.1; 4.4.1, 4.4.3, 4.4.4; 5.4.2

Math: 3.1.1, 3.2.7, 3.5.1, 3.5.2; 4.5.1, 4.7.4; 5.6.1, 5.6.2

English/Language Arts: 3.2.7, 3.4.3, 3.5.8, 3.7, 3.7.5, 3.7.6, 3.7.7, 3.7.8, 3.7.11, 3.7.12, 3.7.16; 4.2.7, 4.4.5, 4.4.6, 4.4.7, 4.7, 4.7.2, 4.7.4, 4.7.5, 4.7.9, 4.7.11, 4.4.16; 5.2.1, 5.2.6, 5.5.3, 5.6, 5.7

#### National Science Education Standards

##### Grades K–12

Content Standards: Unifying Concepts and Process

- Evidence, models, and explanations

##### Grades K–5

Content Standard A: Science as Inquiry

- Abilities necessary to do scientific inquiry
- Understanding about scientific inquiry

Content Standard B: Physical Science

- Positions and motion of objects
- Motions and Forces (Grade 5 only)

Content Standard E: Science and Technology

- Abilities of technological design
- Understanding about science and technology

Content Standard G: History and Nature of Science

- Science as a human endeavor

National Research Council (NRC). National Science Education Standards. Washington, D.C.: National Academies Press, 1996.

#### National Common Core State Standards

- National Common Core State Standards in Language Arts and Mathematics (See pages 65–67).

## Experience 1: Leonardo da Vinci Parachute Model

### Objectives

#### Data Collection:

Students will:

- observe that a balloon inflated with air takes up more space and has more mass than an identical balloon that is not inflated with air.
- observe that two objects made of the same type and amount of material move differently through air depending on their shape.
- observe that the time it takes a flat piece of paper to travel a given distance is greater than the time it takes the same mass of crumpled paper to travel the same distance.
- build and launch a model parachute and observe that the more paper clips they add to their parachute, the faster the parachute travels the same distance through air.

#### Sense-Making:

Students will:

- explain that air is matter that pushes against objects as they move through it. The greater the amount of surface of an object that comes in contact with air, the more the “push” of the air resists the motion of the object as it moves through the air.
- recall that weight is a measure of the force an object exerts due to gravity.
- begin to develop the idea that pushing or pulling can change the position and motion of objects and the size of the change is related to the strength of the push or pull.
- begin to develop the idea that when an object is being pushed and pulled at the same time,
  - the pushes and pulls will be equal in strength and the object’s motion will be constant or
  - one force will be greater than the other and cause a change in the speed or direction of the object’s motion.
- explain that models are tools used for communicating ideas about objects, events, and processes, including flight. Models do some things well but have limitations.

### You Will Need

- Student Handouts
  - Test Flight Research Card Paper Drop
  - Leonardo da Vinci Parachute Directions
  - Leonardo da Vinci Parachute Flight Research Card
  - NASA Mission: Spacewedge
  - NASA Career: Life Support Technician
- 2 balloons (teacher demonstration)
- 2 pencils (teacher demonstration)
- Paper
- Thread or string – 18" per student
- Kite string or thread – 20' per student
- Paper clips
- Tape
- Pencil or marker
- Website: [childrensmuseum.org/flightadventures](http://childrensmuseum.org/flightadventures)
- CSI Flight Adventure journals

**Time:** 90 minutes

### Literature Connection

Cole, Joanna. *The Magic School Bus Taking Flight*. New York: Scholastic, 1997. Ms. Frizzle and her class find out about how things fly.

### Key Terms

canopy	parachute
gravity	pyramid
matter	shroud lines
mass	surface area
model	weight

### Background

This lesson has an online video component suitable both for teacher background information and viewing by students. The lessons are designed to be complete as written. **However, it is highly recommended that teachers preview the video segments before class and then use them in the presentation of each lesson.**

View the following CSI Flight Adventure videos:

- *Introduction to CSI Flight Adventures*
- *Paper Ball Demonstration*
- *Building and Launching the Leonardo da Vinci Parachute*

#### NASA Website for Students: What Is Aerodynamics?

[nasa.gov/audience/forstudents/k-4/stories/what-is-aerodynamics-k4.html](http://nasa.gov/audience/forstudents/k-4/stories/what-is-aerodynamics-k4.html)

A beginner’s guide to the science of flight.

#### NASA Website for Teachers: Aeronautics

[nasa.gov/topics/aeronautics/index.html](http://nasa.gov/topics/aeronautics/index.html)

News and features about NASA research.

#### NASA Website for Teachers: Flexible Wing Design Used for Hang Gliders

[nasa.gov/audience/foreducators/topnav/materials/listbytype/NASA\\_at\\_50\\_1961.html](http://nasa.gov/audience/foreducators/topnav/materials/listbytype/NASA_at_50_1961.html)

Video, audio, and teachers guide for hang gliders.

#### NASA Website for Teachers: Key Terms

[nasa.gov/audience/foreducators/nasaclips/toolbox/vocabulary.html](http://nasa.gov/audience/foreducators/nasaclips/toolbox/vocabulary.html)

#### NASA Website for Students: Key Terms– Picture Dictionary

[nasa.gov/audience/forstudents/k-4/dictionary/index.html](http://nasa.gov/audience/forstudents/k-4/dictionary/index.html)

### Teacher Tip: Parachute Flight Problems and Solutions

Flight Path	Correction
Flies straight, glides smoothly	Do not make any changes
Wobbles back and forth	Make sure object is centered
Falls fast	Reduce the weight of the object
Falls fast	Make sure canopy is airtight

## Lesson One

<b>Challenge 1</b>	Build, test, and fly a model through air.
<b>Challenge 2</b>	Change the speed of a model moving through air.

### Focus Question:

How can we demonstrate and observe that air is matter?



## Procedures

### Air is Matter

- Matter:** Help students develop the idea that air is something (matter), using two balloons. Hold up the two balloons (not inflated) and show that they are the same size, shape, and material. (You may pass them around so students can observe this for themselves.) Point out to the class that they are made of rubber. Rubber, like all objects, is made of particles that cannot be seen, called **matter**.
- Air:** Ask students: What is air made of? Is it something or nothing? Record students' ideas on the board or on a flip chart. Tell students that all matter has two characteristics: it takes up space and has mass. Write the following sentence on the board:

*Matter takes up space and has mass.*

- What Inflates a Balloon?** Inflate and tie the end of one balloon. Then ask the class to compare how the inflated balloon is alike and different from the one that is not inflated. Students should understand that the balloons are still made of the same material and that the only change is that air has been added to one balloon.
- What is Mass?** Next, balance a pencil across the balloon that is not inflated, and balance another on top of the inflated balloon. Ask students to describe what is holding the pencil on the inflated balloon higher. Guide students to understand that adding air to the balloon has added more mass and changed the amount of space it takes up. Therefore, air is matter. It is easy to observe that the air takes up space. Write the following on the board:

*Air is matter because it takes up space and has mass.*



WIKIPEDIA

### Leonardo's Parachute Design

Leonardo da Vinci dreamed of flying. He studied birds and made hundreds of sketches trying to unlock the secret of flight. Drawings of bird wings and plans for flying machines filled his science journals. He was never able to build machines that actually flew because he did not understand the physics of flight.

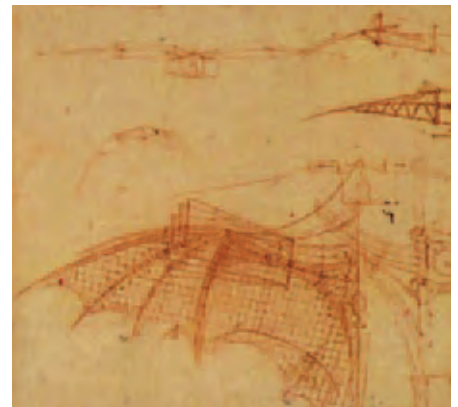

WIKIPEDIA

## Student Activity: The Paper Drop Test

### Focus Question:

**Does the shape of paper affect how it moves through the air?**

**1. Drop the Ball:** Pass out copies of the five student handouts found on pages 16–20 of this unit. Direct students to cut the Paper Drop Test handout into two parts along the dotted line. (You may want to point out that this was a physical change, not a chemical change to the paper. The two pieces are still paper, and of equal size and shape.) The top half of the paper is the Flight Research Card. Ask students to crumple the bottom half of the paper into a ball. Direct them to lift the balls of paper above their heads. Ask students to predict what will happen when they let go of the paper balls. What happened? Record their observations on the board.

**2. Shape Up:** Next, tell students to use the top half of the paper, the Flight Research Card. Direct students to fold up the edges along the dotted line. Demonstrate how to pinch the corners to make a lid shape. (See the drawing on this page.) When finished, they should have made a model that looks like a shoebox lid. Point out that both objects—the lid and the ball—are made from the same paper and started as the same size paper. Ask students to predict what will occur when this piece of paper shaped like a shoebox lid is dropped. Will it fall faster, slower, or at the same speed as the crumpled paper? Ask students to drop the lids with the edges facing down and observe what occurs. Discuss what happened.

**3. On the Surface:** Direct the class to follow your lead in this next demonstration. Take the crumpled paper ball and wave it like a fan in front of your face. Ask the students to do the same. Do they feel any air moving? Repeat this procedure with the folded paper lid. Ask students if they can feel air moving. Which paper moved more air—the

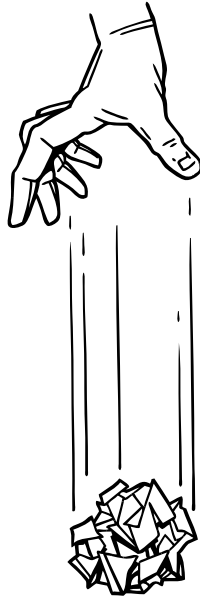

crumpled ball or the folded paper? Why? They should understand that even though both objects are the same material and the same weight, one has a different shape. The folded paper has more **surface area**.

**4. Fair Trial:** Introduce the concept of a “fair trial” to your students. Explain that they will drop both objects—the crumpled paper ball and the folded paper lid—at the same time from the same height. Stress to your students that when they do this science investigation, every drop must be a “fair trial” and re-dropped if it is not. Ask students to predict what will occur. Then let them drop both papers in a fair trial. The folded lid will fall more slowly than the crumpled ball. Students should observe that although both objects are made of the same type of material and have the same mass, the shapes of the objects are different: one is small and rounded and the other is large and flat.

**5. Paper Drop Test:** Explain to students that every NASA test pilot has a flight data card to record research on every flight. Show them how to note if the crumpled paper ball landed first or last compared to the flat paper lid. Emphasize why each object used should be the same size and mass. Students will complete five drops and record the data on their Flight Research Card.

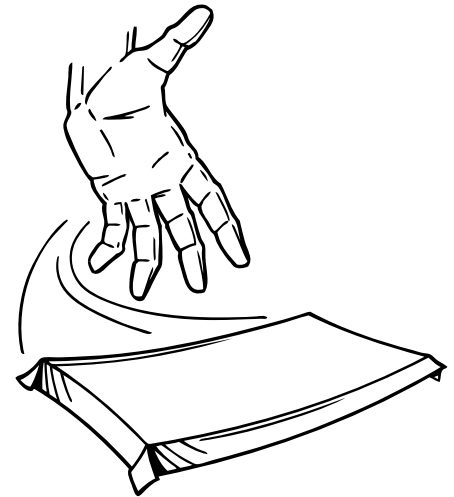

### Follow-up questions:

- How did the shape of the paper affect how it moved through the air?
- What is surface area?
- Why did the flat piece of paper travel more slowly than the crumpled piece of paper?

Solicit student responses and guide them to understand that air, which they now understand is matter, was pushing up on both pieces of paper. The paper ball, because it has less surface area, came into contact with less air than the flat lid shape. Students should understand that the more of an object that comes in contact with air, the more the “push” of the air resists the motion of the object moving through it. The flat lid has more surface area than the crumpled paper ball. The paper ball moves through the air faster because less air is pushing against it.



### Stopping Point.

You can split the lesson here.

**Student Activity: Leonardo da Vinci Parachute Model**

**Focus Question:**

**How does the shape of an object help to slow it down as it falls through air?**

1. Pass out the materials and student handout. Share the story of the scientist Leonardo da Vinci and his **parachute**. Leonardo da Vinci had an idea for a **pyramid**-shape parachute. Read to students what he wrote on his sketch of it: "If a man have a tent made from linen of which the apertures [openings] have all been stopped up, and it be twelve *braccia* [about 23 feet] across and twelve in depth, he will be able to throw himself down from any great height without suffering any injury." Have students make scale drawings in their CSI Flight Adventure Journals of the device that Leonardo was describing. Tell the students that parachutes are used today by NASA and in many other aviation and non-aviation settings. Drag racers use them to slow down, pilots use them for safety, and the space shuttle and other spacecraft use them on landing. Tell students that Leonardo never made his parachute, but they will be following his plans to make and test his design.

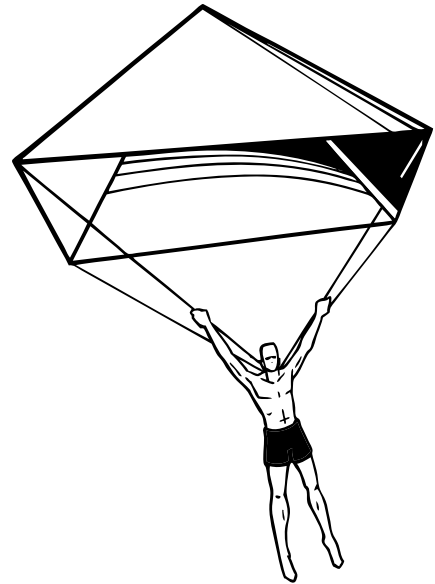
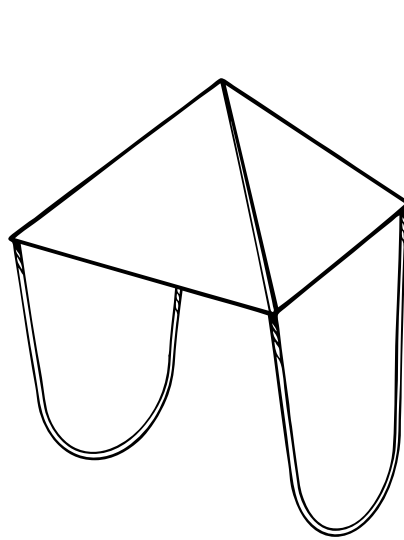
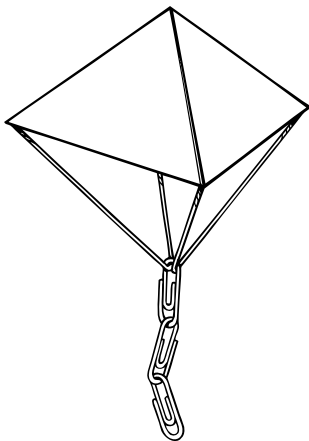

2. **Building the Leonardo da Vinci Parachute:** Instruct students to follow the steps on the student handout to build the parachute:
  - a. Cut out the template of the parachute by cutting along the solid lines.
  - b. Tell students to put their name on the parachute and label it the "Leonardo da Vinci Parachute."
  - c. Fold the paper along the dotted lines. Make sure students know to cut and fold carefully to make a centered and balanced model.
  - d. Carefully tape the TAB to the **canopy** side to make a four-sided pyramid shape. It will have one point at the top and four corners at the bottom.
  - e. Cut the 18" string in half to make two **shroud lines**. Tape the two ends of one piece of string to two corners of the parachute. Tape the ends of the other piece of string to the other two corners where a star (★) is placed. When finished, there will be two loops hanging down.

**Teacher Note:** Teachers may want to increase the number of paper clips from 3 to 5 to make the parachute fall more quickly.

3. **Launching and Testing the Parachute:** The parachute is complete and ready to fly. Place students in pairs to complete the investigation and collect data on how **weight** affects a falling object. One student drops both parachutes at the same time from the same height, while the other student judges which one landed first. Then have students add one paper clip to one parachute and five paper clips to the other. Students should conduct five drop trials and record their answers on the Flight Research Card.

**Follow-up questions:**

- What is weight?
- How does the weight of an object affect how it moves through air?
- How was the parachute different from the crumpled paper ball and the flat lid?
- How did the model you made help you understand how things fly?
- What else do you want to know about flight that the model can't show you?



One of the Spacewedge remotely piloted research vehicles in flight under a steerable parafoil during 1995 research flights conducted by NASA's Dryden Flight Research Center.

PHOTO COURTESY OF NASA



With drag chute unfurled, space shuttle Atlantis lands on Runway 33 at the Shuttle Landing Facility at NASA's Kennedy Space Center in Florida after 11 days in space, completing the 4.5-million mile STS-129 mission.

NASA/KIM SHIFLETT NOV. 27, 2009

### Experience Assessment

Ask students to answer the following application question:

NASA engineers developed a 120-pound spacecraft called the Spacewedge that was designed to re-enter Earth's atmosphere and land safely with a built-in parachute. Using what you have learned in your investigations, explain how the Spacewedge parachute lowers the craft to Earth without crashing.

### NASA Aeronautics Student Reports

Aircraft models have been tested in wind tunnel facilities at NASA Langley, NASA Ames, and NASA Glenn research centers, and at NASA Dryden Flight Research Center. Wind tunnels at NASA Marshall Space Flight Center have been and continue to be used to develop launch vehicles. Teachers may want to assign a student report about one of the following topics to research and prepare a report on.

- Parawing Utility Vehicle
- Drogue Parachutes
- Ejection Seat
- NASA Langley Research Center
- NASA Dryden Flight Research Center
- NASA Ames Research Center
- NASA Glenn Research Center
- NASA Marshall Space Flight Center
- NASA Career: Life Support Technician
- NASA Fact Sheet: Spacewedge

Information can be found at [nasa.gov](http://nasa.gov)

**Curious Scientific Investigators**

**Flight Research Card • The Paper Drop Test • CSI Flight Adventure**

Name: \_\_\_\_\_

Date: \_\_\_\_\_



Cut this student handout into two equal parts. Crumple the bottom half of the handout to make the paper ball. Fold up along the dotted lines of this Flight Research Card to make the folded paper object. Pinch the corners to make a box lid. Hold high and drop each object at the same time for a “fair test.” Record how the objects fall by writing (F) for the object that lands first and (L) for the object that land last. What does surface area have to do with your results?

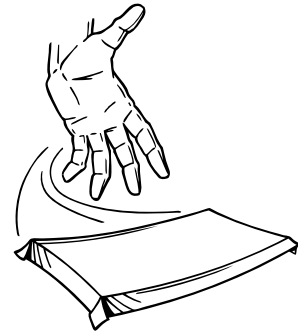

Object	Fair Drop Trial 1	Fair Drop Trial 2	Fair Drop Trial 3	Fair Drop Trial 4	Fair Drop Trial 5
Folded Paper					
Paper Ball					

-----  
**Cut paper in half along this dotted line.**

**Crumple this half into a paper ball.**



Curious Scientific Investigators

Flight Research Card • Leonardo da Vinci Parachute • CSI Flight Adventure

Name: \_\_\_\_\_

Date: \_\_\_\_\_

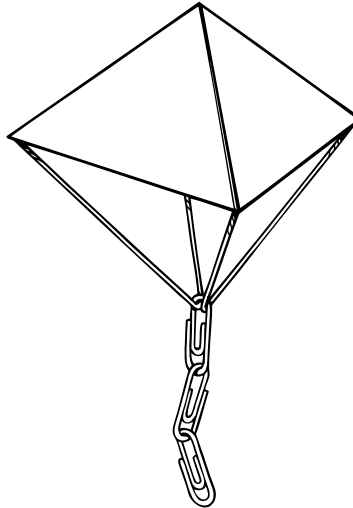
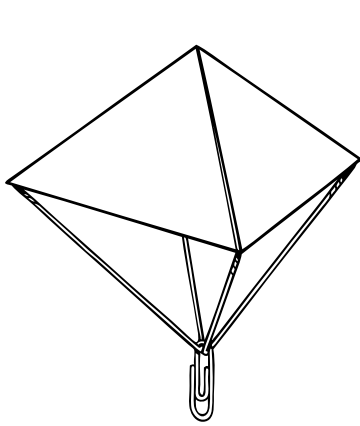

Leonardo's parachute design

Different Weights

Work with a partner to collect data on how parachutes fall through the air. One student drops both parachutes and the other records data. Switch positions so each student has the chance to drop the parachutes. Record your data by writing which lands first (F), and which lands last (L) on each drop test. Make sure each drop is a fair test.

Object Canopy	Fair Drop Trial 1	Fair Drop Trial 2	Fair Drop Trial 3	Fair Drop Trial 4	Fair Drop Trail 5
1 Paper Clip					
3–5 Paper Clips					

What did you observe when more paper clips were added to the falling parachute?

What is a fair drop test? What is not a fair drop test?

How did increasing the weight of the parachute affect how quickly it traveled a given distance?

If you made a hole in the top of the parachute would it fall slower, faster, or at the same rate? Why?

**Curious Scientific Investigators**  
**Make a Leonardo da Vinci Canopy**

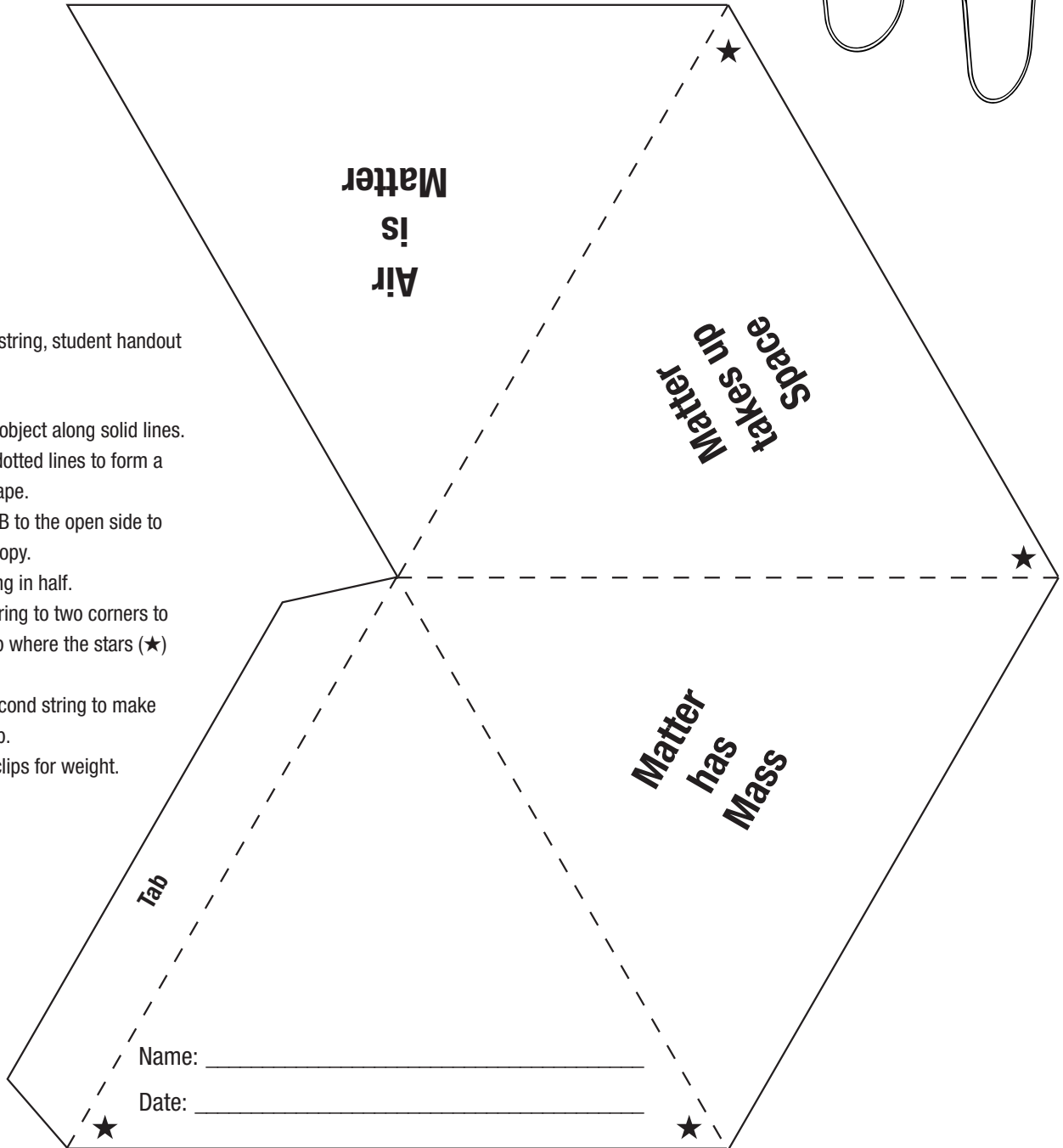
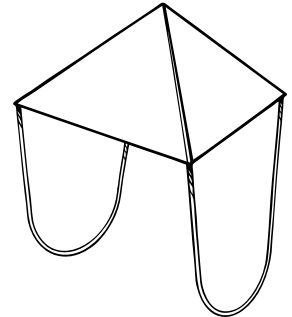

**Materials**

scissors, tape, string, student handout

**Procedures**

1. Cut out the object along solid lines.
2. Fold along dotted lines to form a pyramid shape.
3. Tape the TAB to the open side to make a canopy.
4. Cut the string in half.
5. Tape one string to two corners to make a loop where the stars (★) are located.
6. Tape the second string to make another loop.
7. Add paper clips for weight.

**Curious Scientific Investigators**  
**NASA Fact Sheet: Spacewedge**

Name: \_\_\_\_\_

Date: \_\_\_\_\_

The Spacewedge model uses a special parachute called a parafoil to safely return an aircraft to the ground. A parafoil is a parachute in the shape of a wing. It can be steered on the way down. In the 1990s, NASA's Dryden Flight Research Center, in Edwards, California, tested this large model. Four Spacewedge models were made and tested. The Spacewedge had an automatic system for landing. It was a way to recover astronauts and spacecraft from space.

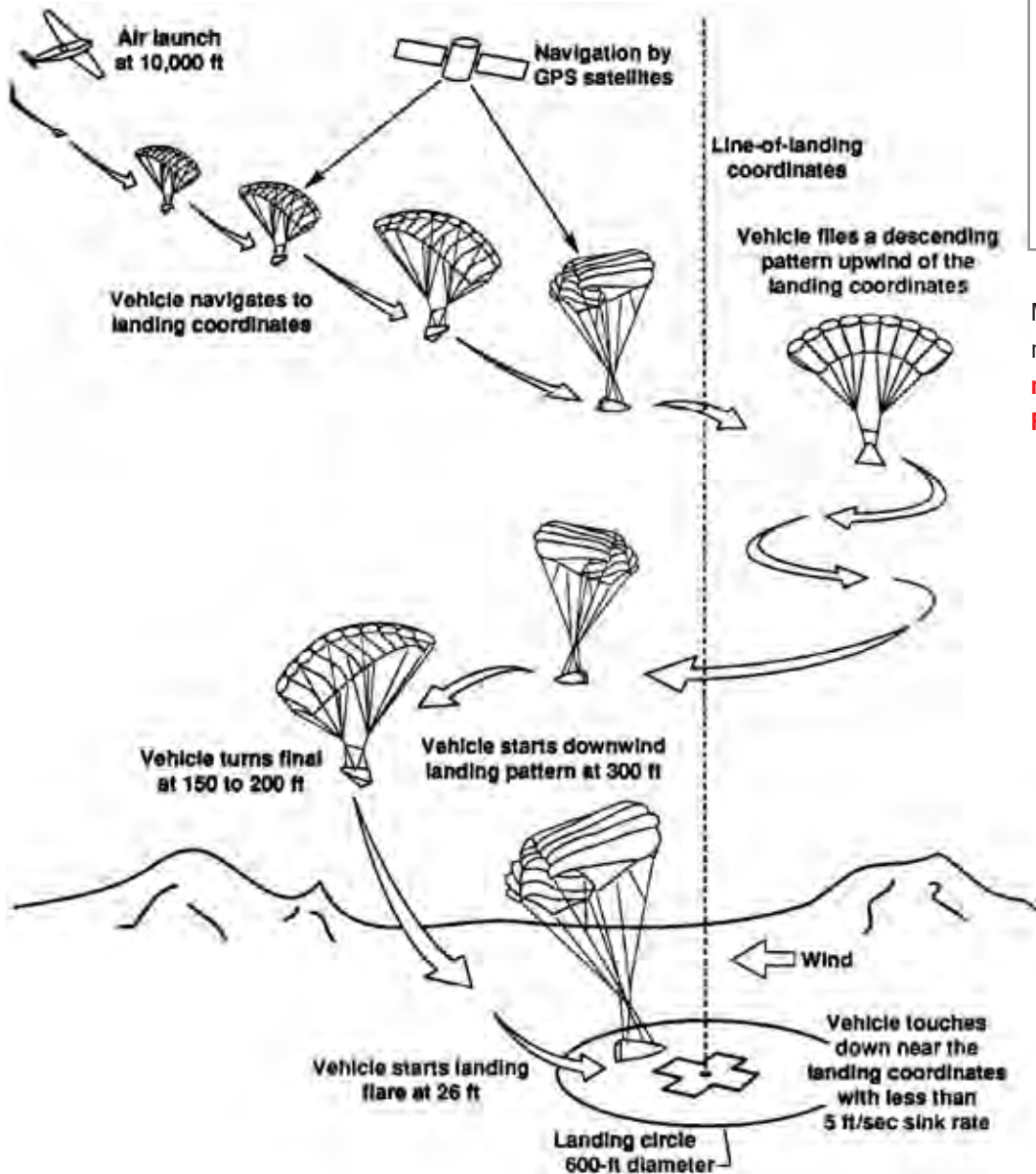

Read about the Spacewedge. Then use the back of this page to answer this question: How does the Spacewedge parachute lower the craft to Earth without crashing? Use what you have learned in your investigations to explain.

View a video of the Spacewedge at: [childrensmuseum.org/flightadventures](http://childrensmuseum.org/flightadventures)

More information including reference material is available at [nasa.gov/centers/dryden/news/FactSheets/FS-045-DFRC.html](http://nasa.gov/centers/dryden/news/FactSheets/FS-045-DFRC.html)

NASA researchers made many flight tests to develop the Spacewedge design. A parafoil was selected for tests. Sport parachutists use these parachutes. The large size allows the vehicle to land without flaring and without sustaining damage.

ILLUSTRATION COURTESY OF NASA

**Curious Scientific Investigators**  
**NASA Career: Life Support Technician — Parachutes**

After you build and test a model parachute, learn about a related NASA career. Read about the job of a life support technician. As a class, discuss the following question: *Why would a life support technician be interested in how a parachute works?*



Jeff Greulich, DynCorp life support technician, adjusts a prototype helmet on a NASA Dryden pilot. Five pilots evaluated the helmet for fit, comfort and functionality during the summer and fall of 2002.

PHOTO COURTESY OF NASA

The Life Support Equipment Branch at NASA helps keep the crew safe on a flight mission. Life Support Technicians take care of all the important personal equipment: helmets, oxygen masks, flight clothing, gravity suits (called G-suits), parachutes, and other survival items. These items are used by all pilots and aircraft crewmembers to ensure a safe mission, and also help them survive an emergency situation. Life Support Technicians conduct emergency and survival training for everyone who flies. They regularly inspect and service the following:

**Flight Helmets and Oxygen Masks**

Flight helmets protect crewmembers from noise and impacts. Helmets also contain microphones and speakers for communication. Oxygen masks must be tested and fitted before each flight to make sure they are ready in case of an emergency.

**Anti-Gravity “G-Suits”**

The G-suit (gravity suit) helps the pilot or crewmember from losing consciousness or “blacking out” when the aircraft moves quickly. It contains air pockets that put pressure on the legs and lower abdomen. As the G-suit tightens, it helps prevent rapid flow of blood and oxygen away from the torso, which can cause a “blackout.”

**Parachute Systems**

A parachute is rarely needed by NASA flight crewmembers, but it must perform properly when used. Like all survival items, parachute systems are inspected regularly and used in crew training.

Learn more about Life Support Technicians by watching an interview at: [childrensmuseum.org/flightadventures](http://childrensmuseum.org/flightadventures)

## Experience 2: Indoor Paper Box Kite Model

<b>Challenge 1</b>	Build, test, and fly a model through air.
<b>Challenge 2</b>	Change the speed of a model moving through air.

### Overview

In this experience students investigate how moving air causes a kite to fly. Students construct a paper box kite to investigate weight and lift. Students build and fly the model and collect data and record observations on a Flight Research Card.



### Objectives

#### Data Collection:

##### Students will:

- build and fly a model paper box kite.
- observe that a kite lifts off the ground despite its weight due to the opposing forces exerted by the string and by moving air.

#### Sense-Making:

##### Students will:

- explain that **lift** describes what happens when the push of air on an object overcomes the object's weight and pushes it up.
- continue to develop the idea that
  - pushing or pulling can change the position and motion of objects.
  - the size of the change in motion is related to the strength of the push or pull.
- explain that models are tools used for communicating ideas about objects, events, and processes, including flight. Models do some things well but have limitations.

### You Will Need

- Student handouts
  - Flight Research Card Box Kite
  - Box Kite Directions
  - Flight Research Card Sled Kite
  - Sled Kite Directions
  - NASA Mission: Parsev – Rogallo Wing
  - NASA Career: Videographer
- Thread/String
- Scissors
- Clear or masking tape
- Pencil
- Electric fan
- Website: [childrensmuseum.org/flightadventures](http://childrensmuseum.org/flightadventures)

### Key Terms

force	lift
gravity	weight
kite	

## Lesson One

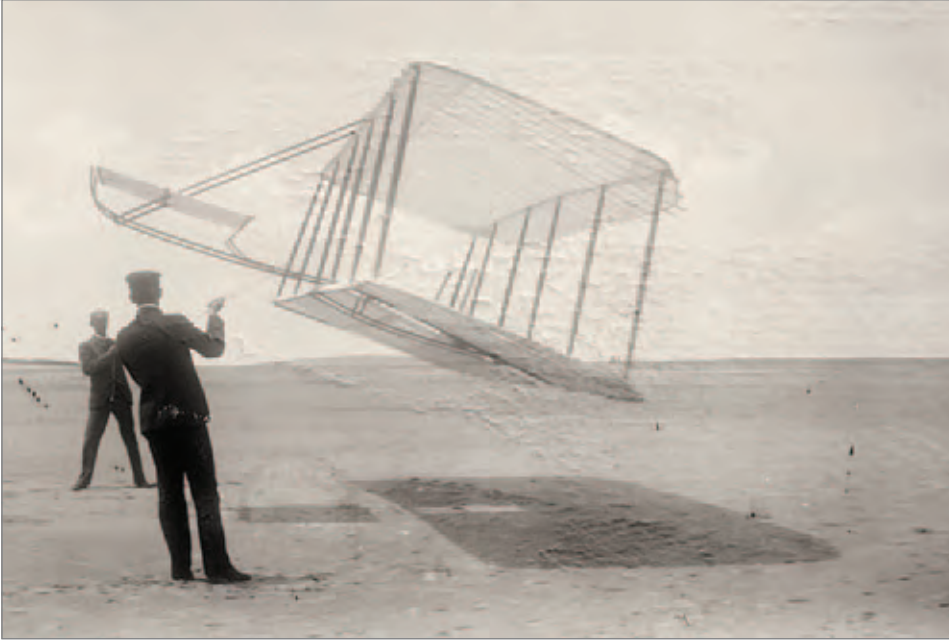

The photograph above shows the Wright Brothers at Kitty Hawk, North Carolina, with their 1901 Glider being flown as a kite. It weighed 98 pounds and had a wingspan of 22 feet. The kite appears to be floating in the air, but it is actually being held motionless because the forces that are acting on it are “balanced.”

PHOTO COURTESY OF NASA

### Background

People around the world have used kites for hundreds of years for military observation and even to look for fish from a vessel at sea. The Wright brothers used a kite to learn how to control an aircraft. When air moves against the surface of a kite, it exerts a force. When the force of the moving air is greater than the weight of the kite, the kite lifts off the ground and flies. The kite—because it is being pulled with an attached string—exerts an equal but opposite force against the moving air. When the force due to the moving air and the force exerted by the kite string are equal, the kite stays aloft.

### NASA Website for Students: The Beginner’s Guide to Kites

[www.grc.nasa.gov/WWW/K-12/airplane/bgk.html](http://www.grc.nasa.gov/WWW/K-12/airplane/bgk.html)

Teaches basic math and physics that govern the design and flight of kites.

### NASA Website for Teachers: Courage to Soar

[nasa.gov/audience/foreducators/topnav/materials/listbytype/The\\_Courage\\_to\\_Soar.html](http://nasa.gov/audience/foreducators/topnav/materials/listbytype/The_Courage_to_Soar.html)

An integrated unit of scientific experiments, aircraft models, and research topics about aviation.

### Online Support

This lesson has an online video component suitable for teacher background information and viewing by students. The lessons are designed to be complete as written. **However, it is highly recommended that teachers preview the video segments before class and then use them in the presentation of each lesson.**

**Website:** [childrensmuseum.org/flightadventures](http://childrensmuseum.org/flightadventures)

**Video:** *Building and Flying a Paper Box Kite*

### Literature Connection

Mayer, Mercer. *Shibumi and the Kitemaker*. New York: Marshall Cavendish, 1999. After seeing the disparity between the conditions of her father’s palace and the city beyond its walls, the emperor’s daughter has the royal kite maker build a huge kite to take her away from it all.

Michael, David. *Making Kites*. New York: Kingfisher Books, 1993. Provides a step-by-step introduction to kite construction and directions for making various kinds of kites, including a two-stick kite, box kite, super stunter, and wind sock.

### Procedures

#### Focus Question:

**How can air make an object lift off the ground?**

1. Ask students how air can make an object lift up from the ground. Record their ideas on the board or a flip chart.
2. Remind students of their findings from Experience 1: that air is matter and that it exerts a **force** on objects. Remind students that they observed that air can slow down falling objects by pushing up on them, which means that air can change the motion of objects. Have students list things that can be blown up into air by the movement of air (e.g., leaves or feathers). Discuss with your class the difference between a falling object being slowed down by air and an object being lifted off of the ground by moving air.
3. Remind students that **weight** is the force an object pulled by **gravity**. Gravity is the force that pulls objects toward the Earth’s surface. For flight to be possible, the force of an object’s weight must be overcome by a stronger force. Let students know that they will explore how to use moving air to cause a **kite** to fly.

**Student Activity: Paper Box Kite**

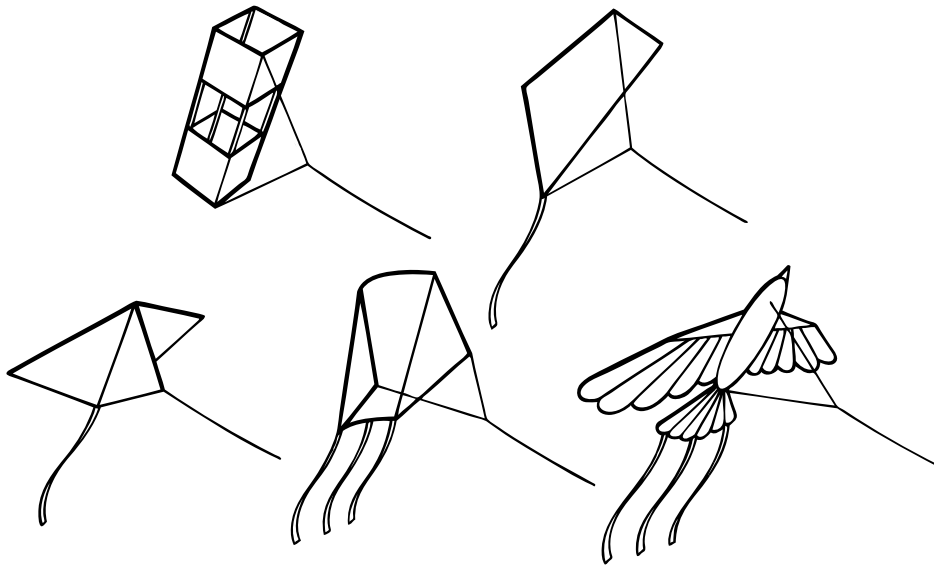

4. Tell the students that there are many different types of kites. Some kites, like the Chinese and Japanese designs, come from hundreds of years of research and flying. Modern kites are made with special materials for special purposes. Regardless of size or type, all kites **lift** into the sky because of the push of moving air. Ask students: What force must be overcome to cause a kite to fly?

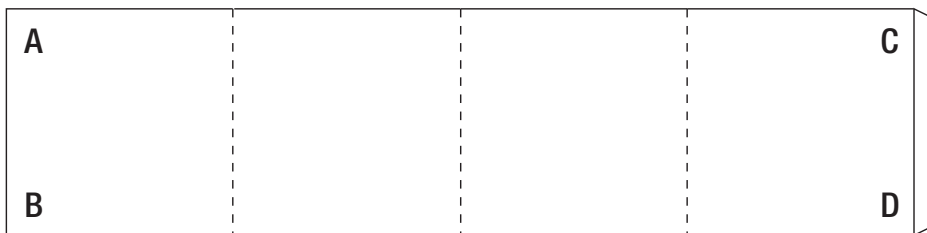

5. **Building the Paper Box Kite:** Distribute the six student handouts found on pages 26–31 of the unit. Instruct students to follow the steps on the handout to build the box kite.
  - a. Cut out the two parts of the box kite.
  - b. Cut out the box kite pattern along the solid lines.
  - c. Fold down along the dash lines so edge A-B touches edge C-D.
  - d. Apply a piece of tape to the TAB to join edge A-B to edge C-D.
  - e. Cut out the tail.
  - f. Tape one end of the tail to the kite at corner B-D.
  - g. Tape the end of the thread to corner A-C.
  - h. Adjust the edges of the kite to form a box.
  
6. **Alternative Sled Kite:** A pattern and instructions for a sled kite is included in this experience extension. This kite is easy to make with inexpensive and readily available materials.



**Stopping Point.**  
You can split the lesson here.

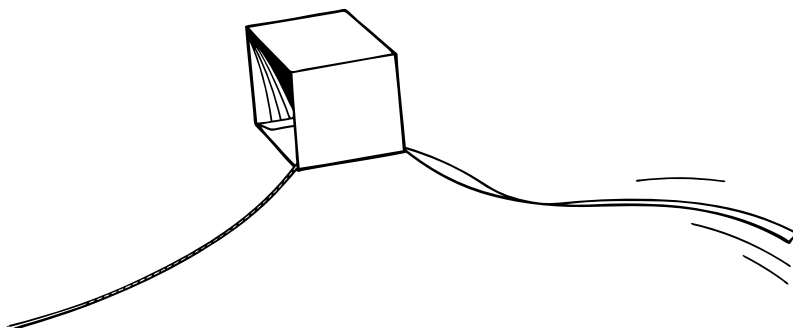

Teacher Tip: Paper Box Kite Trial Flight Problems and Cures	
Flight Path	Correction
Flies straight and smooth	No changes needed
Does not fly	Shorten tail
Bobs up and down	Lengthen tail

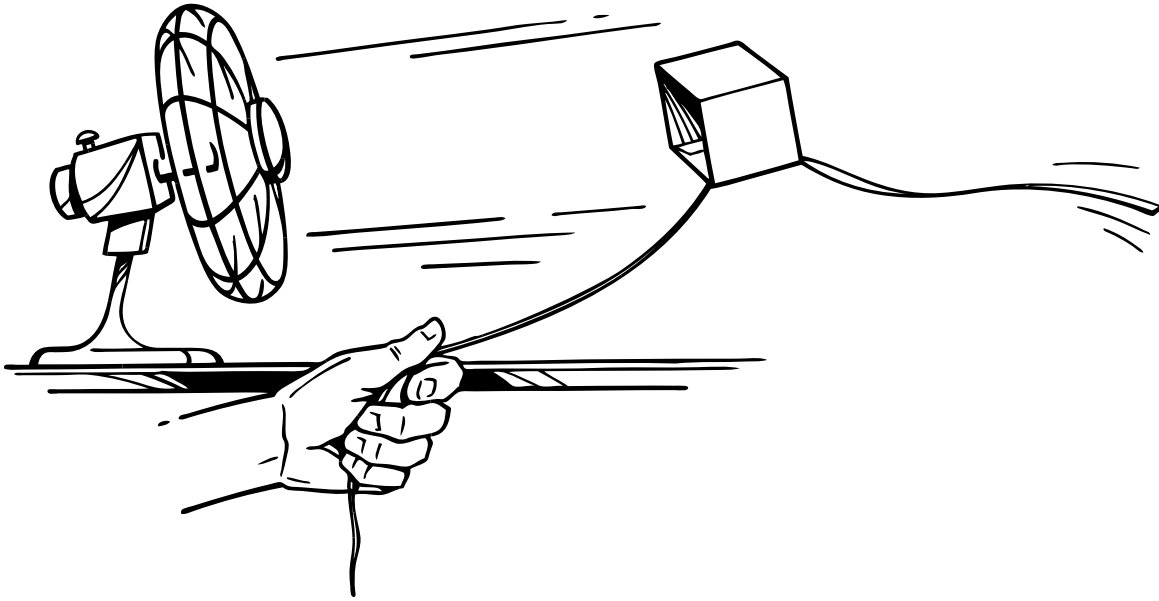

- 1. Flying the Box Kite:** The paper box kite is complete and ready to fly. In the classroom, instruct students to launch the model gently in front of a fan to observe lift. Outdoors, students can run to launch the kites in a gentle wind.
- 2. Testing the Box Kite:** Once students have flown the box kite, ask them to make one of the following changes and fly the kite again. They should record how the kite behaves on their Flight Research Card for each trial.
  - a. Change where the tail is connected to the box kite.
  - b. Add an additional tail.
  - c. Shorten or lengthen the tail.
  - d. Change the speed of the fan.
  - e. Change the length of the kite string.
  - f. Make a larger box kite.

### Sense-Making Discussion and Questions

Ask students to predict what is needed to make a heavier kite fly into the air. *Students should understand that the push of air from the fan lifts the kite. The pushing force and the angle of the air moving on the kite create lift. Two things can be changed to make a heavier kite fly: stronger wind (faster wind speed) or greater air surface.*

Ask students: How did the model you made help you understand how things fly? How was the model not helpful?

### Experience Assessment

Have students read the Paresev Fact Sheet on page 30 and ask them to answer the following application question:

NASA engineers developed the Paresev from kite parachutes in order to safely return a spacecraft back to Earth. Using what you have learned in your investigations, explain how the Paresev lowers the craft to Earth without crashing.



### NASA Aeronautics Student Reports

Aircraft models have been tested in wind tunnel facilities at NASA Langley, NASA Ames, and NASA Glenn research centers, and NASA Dryden Flight Research Center. Wind tunnels at NASA Marshall Space Flight Center have been and continue to be used to develop launch vehicles. Teachers may want to assign one or more of the following topics for students to research and prepare a report on.

- Wright brothers' kite
- Rogallo Wing
- X-38 Crew Return Vehicle
- Parawing Utility Vehicle
- NASA Langley Research Center
- NASA Dryden Flight Research Center
- NASA Ames Research Center
- NASA Glenn Research Center
- NASA Marshall Space Flight Center
- NASA Career Spotlight: Logistics Engineer
- NASA Fact Sheet: Paresev

Information can be found at [nasa.gov](http://nasa.gov)



The Paresev 1-B used the Paresev 1-A space frame with a smaller Dacron wing (400 square feet) and was flight-tested to evaluate its handling qualities with lower lift-to-drag values. One NASA project engineer described its gliding ability as “pretty scary.”

PHOTO COURTESY OF NASA

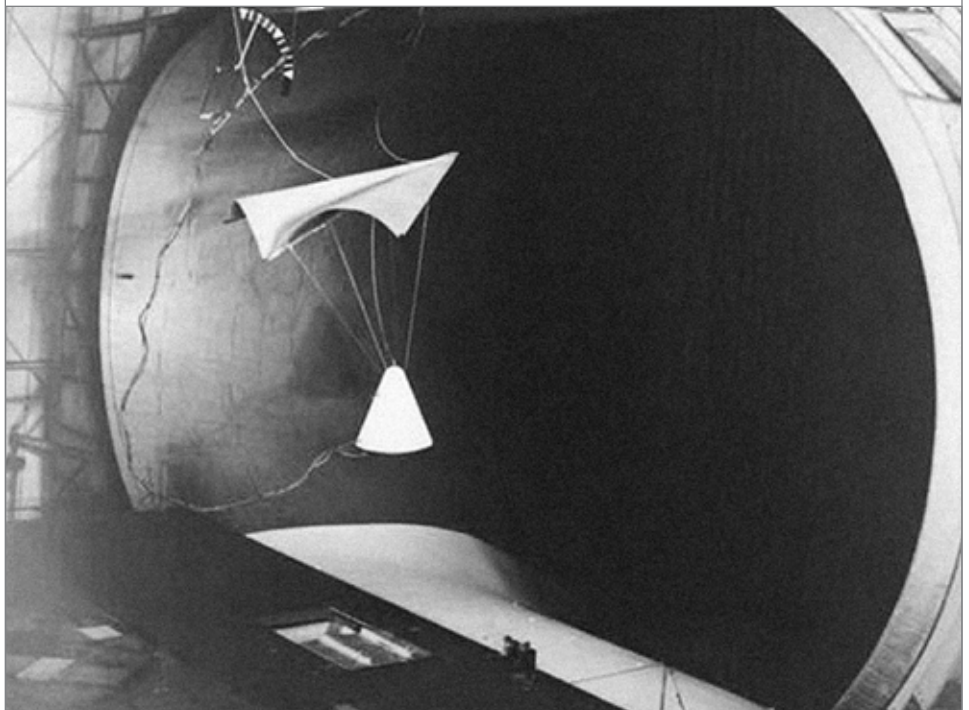

A free-flight model of a parawing utility vehicle being tested at Langley Full-Scale Tunnel.

PHOTO COURTESY OF NASA

**Curious Scientific Investigators**  
**Flight Research Card • Paper Box Kite • CSI Flight Adventure**

Name: \_\_\_\_\_ Date: \_\_\_\_\_

Follow the steps on the student handout to build the box kite. **Materials:** pattern, scissors, tape, thread

1. Cut out the two parts of the box kite in the student handout.
2. Cut out the box kite pattern along the solid lines.
3. Fold down along the dash lines on the kite so edge A-B touches edge C-D.
4. Apply a piece of tape to the TAB to join edge A-B to edge C-D.
5. Cut out the tail.
6. Tape one end of the tail to the kite at corner B-D.
7. Tape the end of the thread to corner A-C.
8. Adjust the edges of the kite to form a box.

Trials and Changes		Describe How the Box Kite Flies
<b>Trial 1</b> <b>First Flight</b>	Draw tail position	
<b>Trial 2</b> <b>Change the position of the tail</b>	Draw tail position	
<b>Trial 3</b> <b>Add another tail</b>	Draw tail position	
<b>Trial 4</b> <b>Shorten the tail</b>	_____ Measure change in inches or centimeters	
<b>Trial 5</b> <b>Lengthen the tail</b>	_____ Measure change in inches or centimeters	
<b>Trial 6</b> <b>Another change</b>		

Using the data you have collected, explain how moving air causes a kite to fly by overcoming its weight.

**Box Kite**

**Kite Tail**

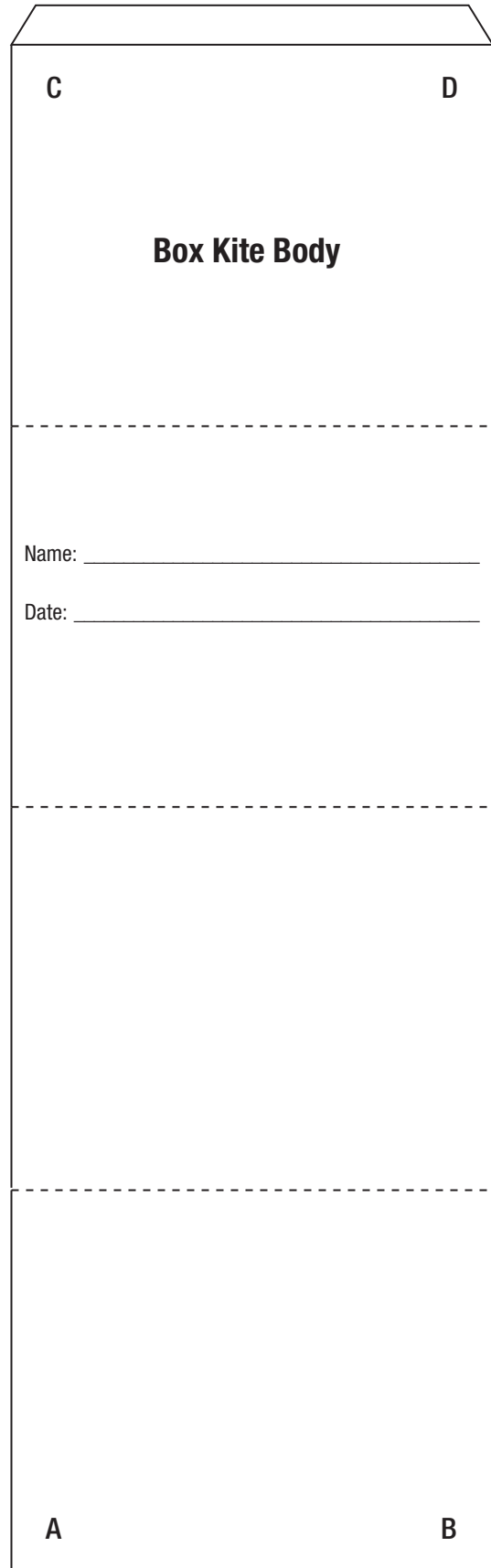
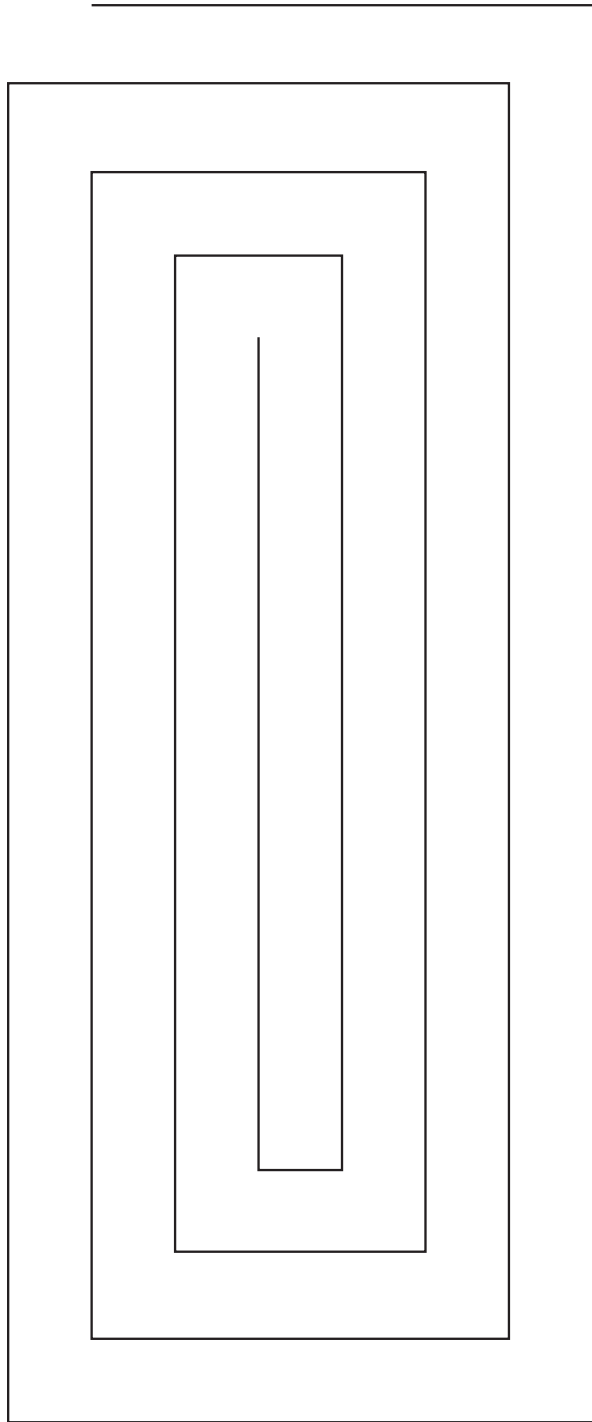

**Curious Scientific Investigators**

**Flight Research Card • Sled Kite • CSI Flight Adventure**

Name: \_\_\_\_\_ Date: \_\_\_\_\_

Wind striking a kite surface will create a force that causes the kite to fly.  
This force can be felt as wind pushes on the kite and the kite tugs on its string.

Trials and Changes		Describe How the Sled Kite Flies
<b>Trial 1 First Flight</b>	Draw tail position	
<b>Trial 2 Change the position of the tail</b>	Draw tail position	
<b>Trial 3 Add another tail</b>	Draw tail position	
<b>Trial 4 Change the tail length</b>	_____ Measure change in inches or centimeters	
<b>Trial 5 Make a bigger or smaller kite</b>	_____ Measure change in inches or centimeters	
<b>Trial 6 Another change</b>	_____ Measure change in inches or centimeters	

Using the data you have collected, explain how moving air causes a kite to fly by overcoming its weight.

### Curious Scientific Investigators

#### How to Build a Sled Kite

Name: \_\_\_\_\_

Date: \_\_\_\_\_

A sled kite is simple to build and a powerful lifting machine in light-to-moderate breezes. You can vary the dimensions of the pattern provided here to create a kite with a different surface area.

**Kite construction:** Complete the following construction steps.

1. Use the dimensions below to create your kite.
2. Cut out one side and the bottom of a standard-size brown paper grocery bag.
3. Unfold the bag and copy onto it the dimensions given in the illustration.
4. Reinforce the bridle-attachment points with tape and attach bridle string (approximately 2 meters in length, depending on the kite). Tie a simple loop knot at the midpoint of the bridle.
5. Decorate as desired using colored markers.

Materials	Tools
Standard-size brown paper grocery bags	Pencils
Masking tape	Meter sticks or rulers
Bridle string	Scissors
Tail (streamers, yarn, or machine tape)	Colored markers

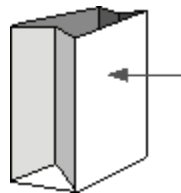

Cut this side and the bottom out.

Kite Diagram

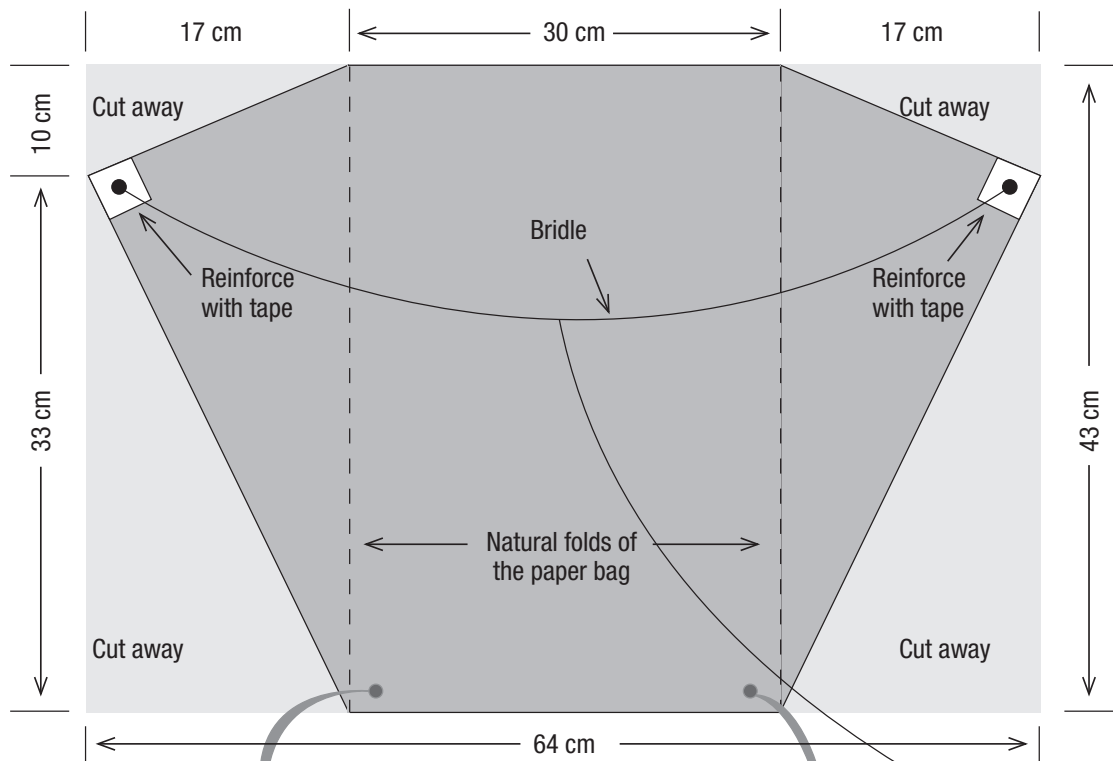

### **NASA Fact Sheet: Paresev (Paraglider Research Vehicle)**

Read about the Paresev and answer the following Sense-Making Question: Using what you have learned in your investigations of parachute and kites, explain how the Paresev lowers the craft to Earth without crashing.



Dryden Flight Research Center • E-8013 • Photographed 1962  
Paresev testing flight-cost issues of the parawing concept.

PHOTO COURTESY OF NASA



Dryden Flight Research Center • E-8713 • Photographed 1962  
Paresev, Stearman biplane and crew with pilot Milt Thompson seated.

PHOTO COURTESY OF NASA

#### **Paresev**

The Paresev (Paraglider Research Vehicle) was developed from kite-parachute studies by NASA Langley engineer Francis M. Rogallo. In the early 1960s the “Rogallo wing” seemed like an excellent way to return a spacecraft to Earth. It had a delta-shape wing design. The Paresev was unpowered, and made from steel tubing referred to as a “space frame.” It looked like a grown-up tricycle with a triangle para wing. The pilot sat out in the open. He controlled how fast he fell by tilting the wing up and down. He used a control stick to turn by tilting the para wing from side to side. The Paresev landed like an airplane.

The Paresev completed nearly 350 flights during a research program from 1962 to 1964. Despite its looks, the Paresev was a useful research aircraft that helped develop a new way to fly. Although the “Rogallo wing” was never used on a spacecraft, it revolutionized the sport of hang gliding.

More information about the Paresev can be found at:

[nasa.gov/centers/dryden/multimedia/imagegallery/Paresev/Paresev\\_proj\\_desc.html](http://nasa.gov/centers/dryden/multimedia/imagegallery/Paresev/Paresev_proj_desc.html)

## NASA Career: Videographer Lori Ann Losey—Senior Video Producer/Director

After you build and test your kite, learn how a NASA videographer records how things fly. Read about a Logistics Engineer and answer the following Sense-Making Question: How does a Videographer help with a NASA mission?

“I grew up in Lancaster, California. While watching my favorite shows on TV, I thought it would be fun to be in commercials. I auditioned and got a part as an extra in a television special. I found that I was more interested in what was happening behind the scenes. After that, I turned my attention to photography classes. It wasn't until I reached college that I had the opportunity to take video classes. I received my bachelor's degree in broadcasting from Pepperdine University. I started working for NASA Dryden in 1988 and am responsible for documenting all of Dryden's research aircraft. My films are used in education, presentations, media releases, and engineering and analysis. I am actively involved in all aspects of producing videos, from writing the script, to directing and shooting the footage, to editing. My job requires me to perform aerial video documentation by flying in a lot of different NASA planes. The most rewarding part is all the different projects I get to work on—flying is kind of cool! You never know what may inspire you to choose a career. It could be as simple as watching your favorite TV show!”



NASA Dryden's Lori Losey was named NASA's 2004 Videographer of the Year in part for her camera work during NASA's AirSAR 2004 science mission in Chile.

PHOTO COURTESY OF NASA

Learn more about Videographers by watching an interview with Lori Losey at [childrensmuseum.org/flightadventures](http://childrensmuseum.org/flightadventures)

### Lesson 2: Moving Through the Air: Thrust and Drag



Technician Durwood Dereng measures elevation of double Deacon booster prior to launch of RM-10 research model at Wallops, February 6, 1951.

PHOTO COURTESY OF NASA

#### Overview

In this lesson students learn about two more forces important for flight. Students construct a rocket using paper, pencil, and tape to investigate thrust and drag. Students build, test, collect data, and record observations using their paper rocket model. They investigate how a single variable on the rocket fin will change the performance of the model. They make careful observations, drawings, and notes as they investigate how the paper rocket model moves.

#### Objectives

##### Data Collection:

###### Students will

- build, test, and fly a model rocket made of paper;
- make and record observations about the flight of a paper model rocket;
- observe that a force must be applied to make a paper model rocket fly; and
- observe that drag increases when they bend the fins on a model rocket.

##### Sense-Making:

###### Students will

- explain that thrust is the force that propels an object through air;
- explain that drag is the force that slows the motion of an object moving through air;
- apply the idea from Lesson 1 (that the more surface of an object air comes in contact with, the more the “push” of the air resists the motion of the object as it moves through it) to explain why changing the fins on the paper model rocket increased drag;
- explain, using the paper model rocket as an example, that the position and motion of objects can be changed by pushing or pulling the object and that the size of the change in the motion of an object is related to the strength of the push or pull acting on the object; and
- demonstrate that models are tools used for communicating ideas about objects, events, and processes, including flight.
- give examples of how models do some things well but have limitations.



## You Will Need

### Materials

- Student Handouts
  - Flight Research Card Paper Rocket
  - Paper Rocket Directions
  - Flight Research Card Paper Rocket Extension: Mean, Median, and Mode
  - NASA Mission: X-1 and X-15
  - NASA Career: Flight Engineer
- Card stock or 3" x 5" index card
- Straws, 1 per student
- Scissors
- Clear or masking tape
- Pencils, one per student
- Meter stick or tape measure
- Website: [childrensmuseum.org/flightadventures](http://childrensmuseum.org/flightadventures)
- Goggles

**Time:** 90 minutes

## Key Terms

drag	mode
fins	range
mean	rocket
median	thrust

## Literature Connection

**A Pictorial History of Rockets, NASA**  
[nasa.gov/pdf/153410main\\_Rockets\\_History.pdf](http://nasa.gov/pdf/153410main_Rockets_History.pdf)

## Teacher Tip: Paper Rocket Trial Flight Problems and Cures

Flight Path	Correction
Flies straight, glides smoothly	Do not make any changes
Banks to the right or left	Align the fins parallel to tube
Spins	Check that fins are straight
Sticks on straw	Loosen rocket tube
Doesn't go far	Check to make sure it is airtight

## Background

### NASA Website for Students: The Beginner's Guide to Rockets

[www.grc.nasa.gov/WWW/K-12/rocket/bgmr.html](http://www.grc.nasa.gov/WWW/K-12/rocket/bgmr.html)

Teaches basic math and physics that govern the design and flight of rockets.

### NASA Website for Teachers: Educator's Guide to Rockets

[nasa.gov/audience/foreducators/topnav/materials/listbytype/Rockets.html](http://nasa.gov/audience/foreducators/topnav/materials/listbytype/Rockets.html)

A comprehensive guide to and history of rockets.

## Online Support

This lesson has an online video component suitable for teacher background information and viewing by students. The lessons are designed to be complete as written. **However, it is highly recommended that teachers preview the video segments before class and then use them in the presentation of each lesson.**

**Website:** [childrensmuseum.org/flightadventures](http://childrensmuseum.org/flightadventures)

**Video:** *Building and Launching Paper Rockets*

## Connecting to Standards

The lessons in this unit of study relate to the following Indiana Academic Standards, the National Science Education Standards (NRC, 1996), and the National Common Core State Standards in Language Arts and Mathematics.

### Indiana Academic Standards

Science: 3.4.1; 4.4.1, 4.4.3, 4.4.4; 5.4.2  
 Math: 3.1.1, 3.2.7, 3.5.1, 3.5.2; 4.5.1, 4.7.4; 5.6.1, 5.6.2  
 English/Language Arts: 3.2.7, 3.4.3, 3.5.8, 3.7, 3.7.5, 3.7.6, 3.7.7, 3.7.8, 3.7.11, 3.7.12, 3.7.16; 4.2.7, 4.4.5, 4.4.6, 4.4.7, 4.7, 4.7.2, 4.7.4, 4.7.5, 4.7.9, 4.7.11, 4.4.16; 5.2.1, 5.2.6, 5.5.3, 5.6, 5.7

### National Science Education Standards Grades K–12

Content Standards: Unifying Concepts and Process

- Evidence, models, and explanations

### Grades K–5

Content Standard A: Science as Inquiry

- Abilities necessary to do scientific inquiry
- Understanding about scientific inquiry

Content Standard B: Physical Science

- Positions and motion of objects
- Motions and Forces (Grade 5 only)

Content Standard E: Science and Technology

- Abilities of technological design
- Understanding about science and technology

Content Standard G: History and Nature of Science

- Science as a human endeavor

National Research Council (NRC). National Science Education Standards. Washington, D.C.: National Academies Press, 1996.

### National Common Core State Standards

- National Common Core State Standards in Language Arts and Mathematics (See pages 65–67).

## Lesson Two

### Experience 1: Paper Rocket Model

#### Challenge 1

Build, test, and fly a model through air.

#### Challenge 2

Change the speed of a model moving through air.

#### Challenge 3

Control a model moving through air.

#### Focus Question:

How does an aircraft overcome its weight and the push of air to lift into the air and fly?

### Procedures

#### 1. Opening Discussion and Teacher

**Demonstration:** Help students review what they learned in Lesson 1 by asking them to explain why a parachute falls slowly to the ground and a kite lifts into the air (air is pushing up on them). Help students recall that weight and lift are opposing forces, and that when one force is greater than another, an object's motion will change, but when they are equal in strength the object's motion will not change. (In other words, if weight is greater than lift, the object will fall).

- Remind students that in Lesson 1 they looked at models that either fell through air or were lifted off the ground by moving air. Tell them that they will now look at objects that take off from the ground. Collect and record students' ideas for discussion later. Next, crumple a piece of paper into a ball and throw it across the room. Then ask students: What caused the paper to move? What caused it stop? Slowly repeat the motion of throwing the paper ball to show students that you applied a force with your arm to make the paper move, and that the force of the air pushing against the paper and the force due to the weight of the paper were greater than the force applied by your throw, causing the paper ball to fall.

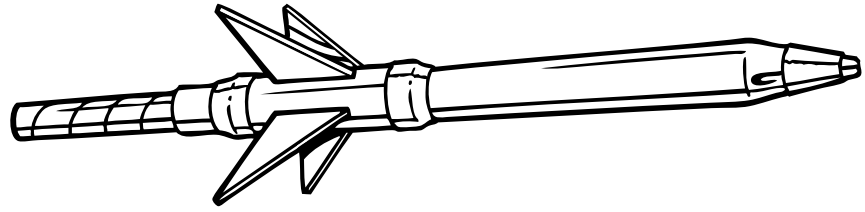

### Student Activity: Building and Testing a Paper Rocket Model

- Distribute the five student handouts for this experience found on pages 37-41 of this unit. Tell students that in this experience they will build a paper **rocket** and test it just like a NASA engineer might test a real one. The paper rocket model to be constructed has three sections, including tube, nose, and  **fins**. Hand out the other materials needed for this lesson.

- Rocket Tube:** Cut a narrow rectangular strip of paper about 5 inches long and roll it tightly around the pencil. Roll the paper at an acute angle less than 90 degrees. This will cause the paper to cover the entire length of the pencil. Make sure that it is not tight on the pencil. If the tube is wound tight it will be difficult to remove from the pencil and the straw will not fit into the body. Have students rewind the paper if this occurs. Remove the tube from the pencil. Make sure it slides back and forth on the pencil. Students may need additional help rolling the paper on the pencil to form the tube. Several attempts may be necessary to make the rocket tube five to six inches long. Tape the tube once it is the correct size. Point out to the students that one end of the rocket tube is thicker than the other end. The thick end will be the bottom of the rocket. The thin end will be the front, or nose, of the rocket.

- Rocket Nose:** Squeeze flat the front end of the rocket tube about 1.5 centimeters (about 1 inch). Crease it and fold it hotdog style. Place your pencil back in the paper rocket tube and push it toward the front. Tape the folded tip of the rocket. Make sure the front end of the paper rocket is airtight and pointed. Remove the pencil and gently blow into the open end of the tube to check for leaks. If air easily escapes, use more tape to seal the rocket tube.

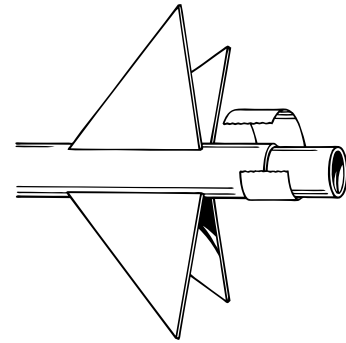

- Rocket Fin:** Cut out two sets of fins using the pattern. Place the pencil back inside the rocket tube to make it easier to tape the fins. Each student should write his or her name on the rocket tube near the fins. Tape the two sets of fins near the open end (bottom) of the rocket tube. Use a small amount of tape to secure the bottom tab of the fin to the bottom of the rocket tube. Make sure that the tape does not stick to the pencil. Repeat with the second rocket fin. Check to make sure that the rocket fins are even and perpendicular to the rocket tube.

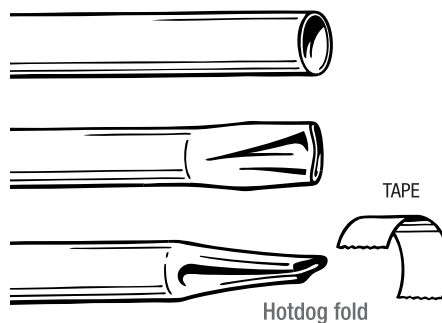

#### Stopping Point.

You can split the lesson here.

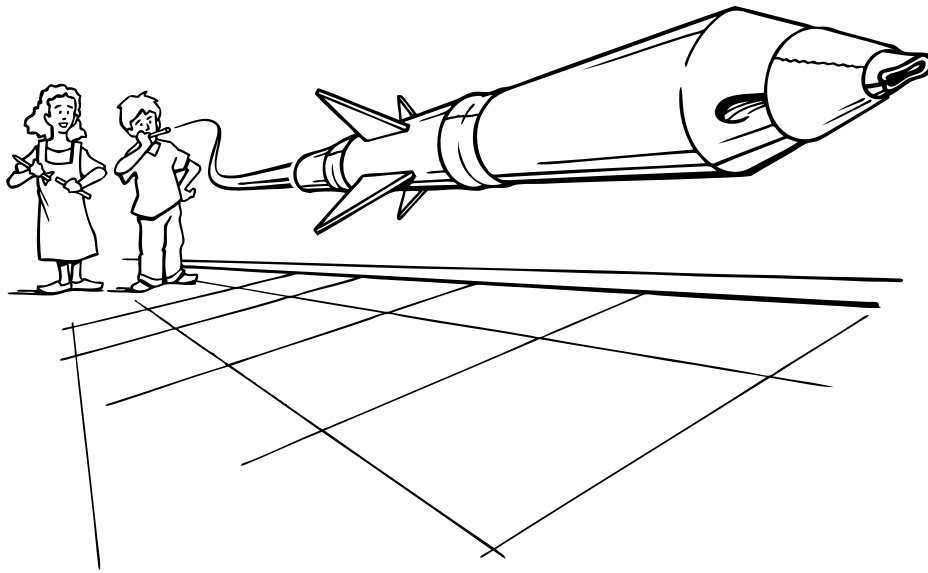

now launchers, and vice versa. Students can complete the investigation in a safe manner by taking turns this way.

**7. Launch Measurements:** In the classroom or a hallway use masking tape to lay out a launch pad and landing area 5 to 8 meters long. (Mark off the area in meters ahead of class in order to save time.) Place markers along the path at regular intervals. Many classrooms, lunchrooms, gyms, and hallways have uniform ceiling or floor tiles that can be used for easier measurement—both to create the launch pad and to estimate the distance the rockets travel. Most ceiling tiles are two- or four-foot sections. Teachers can help students pace the distance based on their own stride. Students need only count their own distance because they are not comparing data with each other.

**8. Teacher-Led Launch:** Students should wear goggles when launching the paper rockets. The following is an effective way to conduct paper rocket launching with students:

- a. Divide the students into two groups: launchers and observers. Each student should have a partner in the opposite group.
- b. Line up the students on opposite sides of the classroom. This system will also work in a larger area—gym, hallway, lunchroom, or other group area.

- c. Direct the launcher group to prepare their rockets for flight. Each student should slip the straw into the rocket's opening at the bottom of the tube. Remind students to be careful not to aim the rocket toward anyone but only toward the landing area. Each student should take a deep breath and blow into the straw to produce a strong push of air as you give a "3, 2, 1, launch!" command. The rocket will be propelled into the air. Each student in the observers group should try to follow the flight of his or her partner's rocket. Do not allow any student to enter the landing area until you give the command.
- d. Direct students to wait for your "All clear!" command before the observer students may enter the landing area. Remind them to look for their partner's name on the rocket without disturbing it from its landing position.
- e. Students should record the distance flown and draw the flight path on their worksheets. Then the rockets may be retrieved.
- f. Repeat the paper rocket launch procedures with the other half of the class from the opposite side of the room. Students who were observers are

**9. Student Launch Trials:** The paper rocket is complete and ready to fly. The first step in flying the model is to make sure it is trimmed to fly in a straight path. Instruct students to gently launch the model directly in front of them and away from any other person. Tell them to make sure to launch the rockets with the same strength and at the same angle each time. Ask them to observe how the paper rocket moves. Show students how to make small adjustments to the rocket fins and tube until the rockets fly in a straight path. Let the students continue to make adjustments after each test flight. Once a paper rocket flies in a straight path for a distance of 5 feet, allow students to complete the launch trials on the student handout Flight Research Card. Students will complete three rocket launches with the fins straight and streamline. They should get long straight flight paths. After students record their observations, they should change the position of the fins. Direct students to bend each of the four fins to control the flight of the rocket. If students bend all four fins in the same direction, the rocket will spiral and have more drag and less distance. Have students complete three more launches. Each flight with bent fins should be a shorter distance than the three when the fins were straight. Rockets should move in a spiral through the air as the air hits and interacts with the fins.

## Lesson Two

### Teacher Tip

Working in pairs, one student can launch and the other can measure; then they can switch. The student handout Flight Research Card Extension: Mean, Median, Mode included in this experience provides math exercises using the paper rocket. Instruct students to complete five launches where they measure the distance and then calculate **mean, median, mode, and range**. Compile all the class data to compare the results. A larger sample of flights may help make better conclusions.

### Sense-Making Discussion and Questions

- Review student responses to the focus question after the paper ball demonstration, and ask: How did you get your paper model rocket to launch? Was that a force? Which one (push or pull)?
- Tell students that the force applied to propel an aircraft into and through air is called **thrust**. Explain that thrust creates lift by causing air to move over the surface of an aircraft. Remind students of the kite example and how the air had to move against the kite to lift it into the air. Ask: How did you cause lift with the paper rocket? What force or forces were opposing the forward motion of the rocket due to thrust and the upward motion due to lift?
- Students should be able to explain that the weight of the rocket and the push of air were opposing lift and thrust. Remind them of the parachute trials: air is matter and pushes against objects that move through it. Tell students that when the push of air resists the motion of an aircraft, it is called **drag**. Have students summarize that weight and drag oppose thrust and lift by drawing a diagram of a rocket and the direction of each force as it flies.
- Ask students how the paper ball demonstration was similar to and different from the trials with their rockets. Guide students to think about the shape of the paper ball and the shape of the rocket, and how they interacted differently with air. Ask: How did the design of the paper rocket affect the way it moved through air? How did the changes you made to the fins change the motion of the rockets? Why?
- Students should be able to apply what they have learned in this experience and previous experiences to explain that the paper rocket was designed to allow air to pass over its body with little resistance (drag), and that when they bent the fins, drag was increased and changed the motion of the rocket (slowed it down and caused it to spin).
- Ask: How did the model you made help you understand how things fly? How was the model not helpful?

### Experience Assessment

Ask students to read the X-1 and X-15 Fact Sheet on page 49 and answer the following application question: NASA engineers developed the X-1 and the X-15 aircraft that broke the sound barrier. These planes flew faster and higher than any previous aircraft. The X-1 and X-15 were designed to fly fast and high. Using what you learned in your investigation, explain how the planes could go so fast.



E17 Drag Research Model

Technician Durwood Dereng prepares to pull the external-power plug from an E17 drag-research model at Wallops, September 8, 1950.

PHOTO COURTESY OF NASA

### NASA Aeronautics Student Reports

Aircraft models have been tested in wind tunnel facilities at NASA Langley, NASA Ames, and NASA Glenn research centers, and NASA Dryden Flight Research Center. Wind tunnels at NASA Marshall Space Flight Center have been and continue to be used to develop launch vehicles. Teachers may want to assign a student report about one of the following topics.

- X-1
- X-15
- Robert Goddard
- Wallops Island Sounding Rockets
- NASA Langley Research Center
- NASA Dryden Flight Research Center
- NASA Ames Research Center
- NASA Glenn Research Center
- NASA Marshall Space Flight Center
- NASA Career: Flight Engineer
- NASA Fact Sheet: X-1
- NASA Fact Sheet: X-15

Information can be found at [nasa.gov](https://www.nasa.gov)

Curious Scientific Investigators

Flight Research Card • Paper Rocket • CSI Flight Adventure

Name: \_\_\_\_\_ Date: \_\_\_\_\_

Build a rocket to investigate thrust and drag.

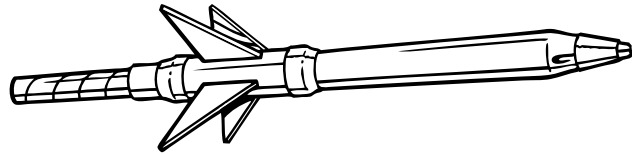

Materials: pattern, scissors, tape, pencils, straws.

1. **Rocket Tube:** Cut a narrow rectangular strip of paper about 5 inches long and roll it tightly around the pencil. Tape the tube. Make sure that it is not tight on the pencil. Remove it from the pencil. Make sure it slides back and forth on the pencil.
2. **Rocket Nose:** Squeeze flat the front end of the rocket tube, about 1 inch. Crease it and fold it hotdog style. Place your pencil back in the paper rocket tube and push it toward the front. Tape the folded tip of the rocket. Make sure the front end of the paper rocket is airtight and pointed.
3. **Rocket Fin:** Cut out two sets of fins using the pattern. Place the pencil back inside the rocket tube to make it easier to tape the fins. Tape the two sets of fins near the open end (bottom) of the rocket tube. Use a small amount of tape to secure the bottom tab of the fin to the bottom of the rocket tube. Make sure that the tape does not stick to the pencil. Repeat with the second rocket fin. Check to make sure that the rocket fins are even and perpendicular to the rocket tube. Put your name on the rocket.
4. **Trials:** Launch your rocket six times. For the first three launches, keep the fins straight to reduce drag. Use alignment guide provided. Then bend the fins to increase drag for the last three launches. Record the distance traveled, the path of the rocket, and any other observations.

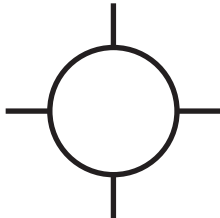
Launch Trials		Record the Distance, Path, and Flight Observations
Trial 1 Straight Fins		 Fin Alignment Guide
Trial 2 Straight Fins		
Trial 3 Straight Fins		
Trial 4 Bend one fin		
Trial 5 Bend two fins		
Trial 6 Bend three fins		
Did the paper rocket move differently when the fins were bent? How?		

Rocket Pattern • Tube and Fins

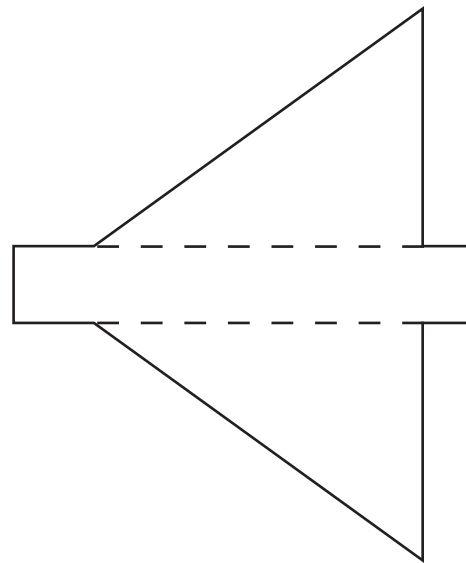
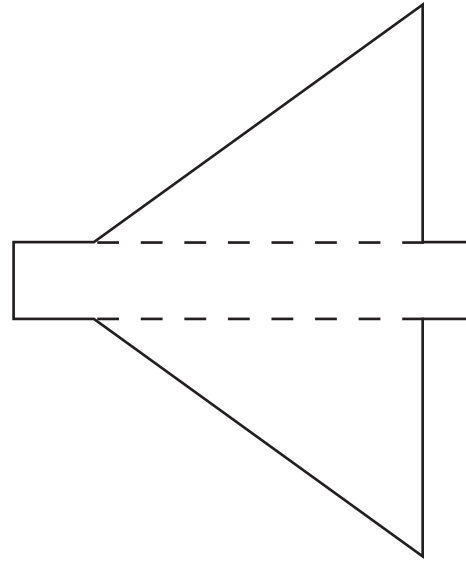
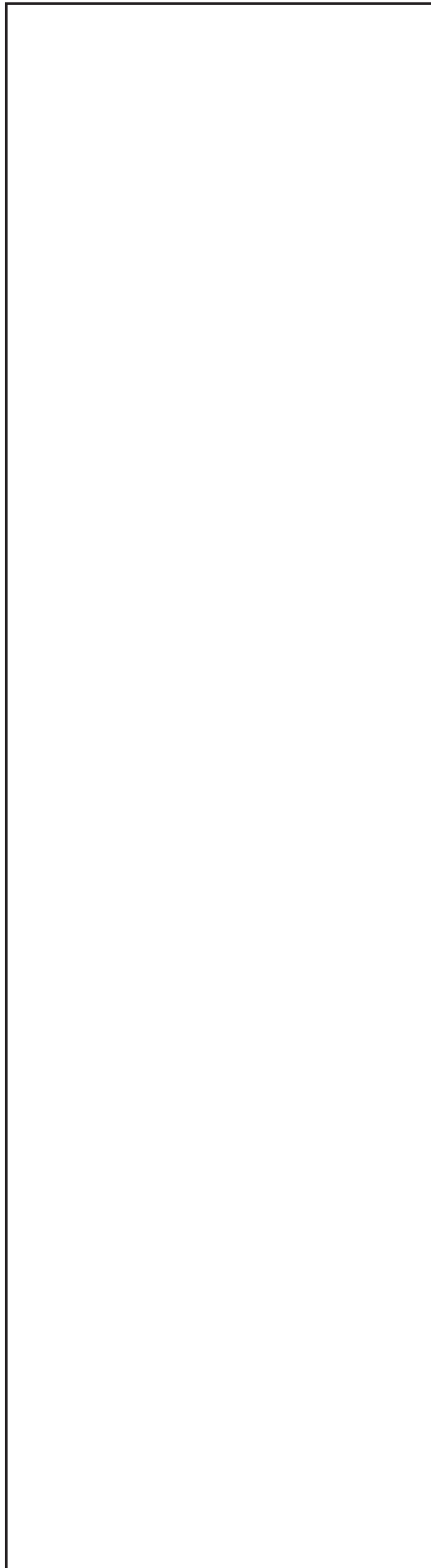

Curious Scientific Investigators

Flight Research Card • Paper Rockets • CSI Flight Adventure

Name: \_\_\_\_\_ Date: \_\_\_\_\_

1. Put on your goggles.
2. Adjust your paper rocket so it flies in a straight path.
3. Keep all the fins (control surfaces) in a straight position.
4. Launch your paper rocket in exactly the same way for each trial. Check to make sure the rocket tube and fins are straight.
5. Use the same amount of force each time you launch the paper rocket.
6. Blow into the straw to propel the rocket across the classroom.
7. Record the distance of each launch on the chart below.

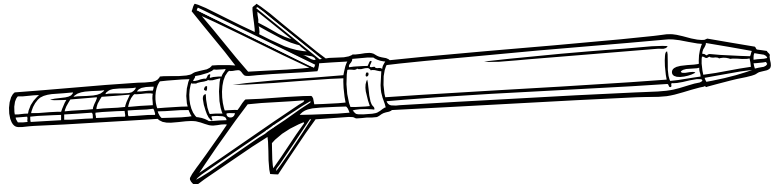

Trial Flights	Total Distance (meters)	Calculations based on distance measurements
1		
2		
3		
4		
5		

Key Terms

**mean:** the average of a group of numerical values. Add all the numerals and divide by the total number of numerals.

**median:** the numerical value at the midpoint in a list of numerals arranged in sequential order.

**mode:** the numerical value that occurs most frequently in a list of numerals. A set of numerals may not have a mode.

**range:** the difference between the lowest and the highest numerical values. Subtract the lowest number from the highest number.

Calculate mean:

Calculate median:

Calculate mode:

Calculate range:

### NASA Fact Sheet: X-1 and X-15

Read about the Z-1 and X-15 and answer the following Sense-Making Question: Using what you learned in your investigation of thrust and drag, explain how the X-1 and the X-15 planes could go so fast.



This particular craft was nicknamed “Glamorous Glennis” by Chuck Yeager in honor of his wife, and is now on permanent display in the Smithsonian Institution’s National Air and Space Museum in Washington, D.C.

USAF PHOTO BY LT. ROBERT A. HOOVER



The X-15 #2 (56-6671) launches away from the B-52 mothership with its rocket engine ignited. The white patches near the middle of the ship are frost from the liquid oxygen used in the propulsion system to cool the payload bay, cockpit, windshields, and nose.

PHOTO COURTESY OF NASA

#### X-1

The X-1 is shaped like a bullet. It was the first high-speed aircraft built for aviation research purposes, in a joint program among NASA, the Air Force, and Bell Aircraft. The bullet-shaped, rocket-powered aircraft became the first airplane to break the sound barrier, on Oct. 14, 1947. Flight research by NASA continued using models and wind tunnels to design high-performance aircraft.

More information about the X-1, including reference material, is available at [nasa.gov/centers/dryden/news/FactSheets/FS-085-DFRC.html](https://nasa.gov/centers/dryden/news/FactSheets/FS-085-DFRC.html)

#### X-15

The X-15 flew a total of 199 flights between 1959 and 1968. This joint program by NASA, the Air Force, the Navy, and North American Aviation worked together on this remarkable rocket research aircraft. Made of titanium and covered with a metal called Inconel X, the X-15 set speed records. The airplane also set an altitude record of 354,200 feet (67 miles) on Aug. 22, 1963. The X-15 program helped NASA aircraft go higher and faster.

View videos of the X1 and X15 at [childrensmuseum.org/flightadventures](https://childrensmuseum.org/flightadventures)

More information about the X-15, including reference material, is available at [nasa.gov/centers/dryden/news/FactSheets/FS-052-DFRC.html](https://nasa.gov/centers/dryden/news/FactSheets/FS-052-DFRC.html)



## NASA Career: Flight Engineer

After you build and test your paper rocket, learn how a flight engineer tests aircraft for NASA. Read about a Logistics Engineer and answer the following Sense-Making Question: How does a Flight Engineer help with a NASA mission?

The NASA Flight Operations Engineering Branch coordinates and schedules all flight research and test projects. Flight engineers work on all projects that involve aircraft or flight vehicles. They make sure all systems and safety tests are carried out before and during the flight. There are several flight engineers on most missions, and they must know all parts of the aircraft. One of their main goals is to make sure that the mission is safe. Flight engineers also must be able to communicate with staff working in all areas of the NASA mission. Flight engineers also work in the Federal Aviation Administration (FAA) and in the flight test branches of the U.S. armed forces.

Learn more about flight engineers by viewing an interview at [childrensmuseum.org/flightadventures](http://childrensmuseum.org/flightadventures)



NASA researchers monitor equipment in the mission control Gold Room at the Dryden Flight Research Center, Edwards, California, during a flight of an F-15 Highly Integrated Digital Electronic Control (HIDEC) research aircraft.

NASA PHOTO / JIM ROSS



NASA Dryden engineer Kathleen Howell and Ikhana project manager Brent Cobleigh check the flight paths in Ikhana's ground control station before takeoff.

NASA PHOTO / TOM TSCHIDA

### Lesson 3: Moving Through Air: Control



F-15B testbed in flight with new sonic shockwave sensor.

NASA PHOTO / JIM ROSS

#### Overview

In this lesson students build and fly an FPG-9 (Foam Plate Glider 9-inch) model to investigate how to control a model plane in flight by manipulating various control surfaces. Using the FPG-9 model, students observe the three axes of flight (ways a plane can move): pitch, roll, and yaw. Students ask questions, collect data, test ideas, record results, and draw conclusions about how and why the FPG-9 moves differently when the control surfaces are adjusted.

#### Objectives

##### Data Collection:

##### Students will:

- observe that an airplane moves around three axes to produce pitch, yaw, and roll;
- observe that moving the elevon (a control surface that combines the functions of an elevator and an aileron) on the FPG-9 will cause the model to move up or down (pitch);
- observe that moving the rudder on the FPG-9 will cause the model to move right or left (yaw);
- observe that moving the elevons in opposite directions (one up, one down) will cause the model to roll;
- build, test, and fly a model airplane; and
- observe that small changes in the control surfaces of a model will affect how the model flies.

##### Sense-Making:

##### Students will:

- distinguish between the three ways an aircraft can move (flight axes): pitch (up and down), roll (around the central lateral axis), and yaw (right or left);
- explain that an aircraft's motion can be controlled because of the predictable movements that adjusting control surfaces produces;
- explain that control surfaces cause changes in an aircraft's motion because of the way air interacts with the surface as it passes over;
- demonstrate how models are used to test ideas and learn about flight by applying their observations of how the FPG-9 moves through air; and
- explain that models are tools used for communicating ideas about objects, events, and processes, including flight.
- give examples of how models do some things well but have limitations.

## You Will Need

- Student Handouts
  - Flight Research Card FPG-9 Glider
  - FPG-9 Glider Directions
  - NASA Mission: F-15
  - NASA Career: Research Pilot
- 9" inch foam plates (use less expensive one-ply plates that will bend.)
- Scissors
- Clear or masking tape
- Ballpoint pens
- Pennies
- Website: [childrensmuseum.org/flightadventures](http://childrensmuseum.org/flightadventures)
- goggles

**Time:** 90 minutes

## Background

### NASA Website for Students: Re-Living the Wright Way

[www.grc.nasa.gov/WWW/Wright/index.htm](http://www.grc.nasa.gov/WWW/Wright/index.htm)

A history of and guide to the accomplishments of the Wright brothers.

### NASA Website for Teachers: Modeling Flight

<http://aeronautics.nasa.gov/ebooks/index.htm>

A comprehensive guide to and history of how models have been used to advance flight.

## Online Support

This lesson has an online video component suitable for teacher background information and viewing by students. The lessons are designed to be complete as written. **However, it is highly recommended that teachers preview the video segments before class and then use them in the presentation of each lesson.**

**Website:** [childrensmuseum.org/flightadventures](http://childrensmuseum.org/flightadventures)

**Video:** *Building and Flying the FPG-9 Glider, AeroLab — Total Control — AMA*

## Teacher Tip: FPG-9 Glider Trial Flight Problems and Cures

Flight Path	Correction
Flies straight, glides smoothly	No changes needed
Banks to the right	Slightly add up left elevon
Banks to the right	Add a little left rudder
Banks to the left	Slightly add up right elevon
Banks to the left	Add a little right rudder
Stalls	Move both elevons down slightly
Dives to the floor	Move both elevons up slightly

## Literature Connection

Yolen, Jane. *My Brothers' Flying Machine: Wilbur, Orville, and Me*. New York: Little, Brown Books for Young Readers, 2003. The story of the Wright brothers from their sister Katharine's point of view.

Busby, Peter. *First to Fly: How Wilbur and Orville Wright Invented the Airplane*. New York: Crown, 2002. A look at the lives of the Wright brothers, from their childhood interest in flight, through their study of successful gliders and other flying machines, to their triumphs at Kitty Hawk and beyond.

## Key Terms

control surface	roll
elevon	rudder
fin	tail
glider	trim
pattern	wing
pitch	yaw

## FPG-9 Glider

The FPG 9 (9" foam plate glider) was invented in 2006 by Jack Reynolds, a volunteer at the National Aviation Museum located in Muncie, Indiana.

## Connecting to Standards

The lessons in this unit of study relate to the following Indiana Academic Standards, the National Science Education Standards (NRC, 1996), and the National Common Core State Standards in Language Arts and Mathematics.

### Indiana Academic Standards

Science: 3.4.1; 4.4.1, 4.4.3, 4.4.4; 5.4.2  
 Math: 3.1.1, 3.2.7, 3.5.1, 3.5.2; 4.5.1, 4.7.4; 5.6.1, 5.6.2  
 English/Language Arts: 3.2.7, 3.4.3, 3.5.8, 3.7, 3.7.5, 3.7.6, 3.7.7, 3.7.8, 3.7.11, 3.7.12, 3.7.16; 4.2.7, 4.4.5, 4.4.6, 4.4.7, 4.7, 4.7.2, 4.7.4, 4.7.5, 4.7.9, 4.7.11, 4.4.16; 5.2.1, 5.2.6, 5.5.3, 5.6, 5.7

### National Science Education Standards Grades K–12

Content Standards: Unifying Concepts and Process

- Evidence, models, and explanations

### Grades K–5

Content Standard A: Science as Inquiry

- Abilities necessary to do scientific inquiry
- Understanding about scientific inquiry

Content Standard B: Physical Science

- Positions and motion of objects
- Motions and Forces (Grade 5 only)

Content Standard E: Science and Technology

- Abilities of technological design
- Understanding about science and technology

Content Standard G: History and Nature of Science

- Science as a human endeavor

National Research Council (NRC). National Science Education Standards. Washington, D.C.: National Academies Press, 1996.

### National Common Core State Standards

- National Common Core State Standards in Language Arts and Mathematics (See pages 65–67).

## Lesson Three

### Experience 1: FPG-9 Glider Model

#### Challenge 1

Build, test, and fly a model through air.

#### Challenge 2

Control a model moving through air.

## Procedures

### Controlling an Airplane

#### Focus Question:

**How can an airplane move in different directions?**

1. Remind students what they discovered in Lessons 1 and 2. Air is matter and it exerts a force on objects as they move through it. Weight and lift are opposing forces that affect how an object moves up and down in air. Thrust and drag are opposing forces that affect how an object moves forward in air. Tell students that in this experience they will use what they have learned about the forces that govern flight to control a model airplane's motion.

### Student Activity: FPG-9 Glider

2. Pass out the four student handouts for this experience found on pages 47–50 of this unit. Tell students they are going to build a special model airplane with control surfaces called the FPG-9. The FPG-9 derives its name from its origins, the venerable and ubiquitous foam picnic plate. The Foam Plate Glider is created from a 9"-diameter plate. They will build and use the **glider** to investigate how aircraft use control surfaces to climb, turn, and maintain stable flight.
3. Pass out the materials and student handouts for this lesson. Introduce the concept of controlled flight to the students. Share how the Wright brothers used kites and gliders to understand ways to control an aircraft in flight.



4. Pass out the FPG-9 **pattern**, tape, penny, and foam plate to each student. Use less expensive foam that bends. Teachers may want to print the FPG-9 pattern on card stock. Some students may benefit from having the template taped onto the foam plate.
5. Instruct students to cut out the paper FPG-9 pattern. Do not cut along the dotted line on the paper pattern. Cut only along the bold lines. (Teachers may want to cut out a set of foam plate master templates for students to trace around.)
6. Place the paper (or foam) pattern in the center of the foam plate, ensuring that the tail of the pattern stays inside the curved portion of the plate bottom. The **tail** must remain on the plate's flat bottom. The tab on the front of the pattern may be on the curve of the plate; it will be folded over later in the construction. The ends of the **wings** should reach the edge of the round plate.
7. Trace around the pattern with a ballpoint pen. Mark lines for the slots A and B.
8. Cut out the foam template by following the pen lines drawn. Cut along the dotted line to separate the tail from the wing. It is better to make all the cuts from the outside of the plate toward the center. Do not try to turn the scissors; instead, cut from a different angle.
9. The wing and the tail each have slots drawn on them. Have the students make a cut along each of these lines. The slots should be only as wide as the thickness of the foam plate. If the slots are cut too wide, the pieces of the plane will not fit together snugly.
10. To attach the tail to the wing, slide slot 1 into slot 2. Use small (2") pieces of tape to secure the bottom of the tail to the top and bottom of the wing. Make sure the tail is perpendicular to the wing before adding tape.
11. In order to make the plane fly successfully, the students must attach the penny on the top of the wing, right behind the square tab. They should refer to the paper FPG-9 pattern. Fold the tab back over the penny and tape it down to secure the coin. This adds weight to the front of the plane, allowing it to fly farther. Ask students to put their name on the FPG-9.



#### Stopping Point.

You can split the lesson here.

12. **Teacher-Led Launches:** The following is an effective way to conduct FPG-9 glider launching for the students:
  - a. Divide the students into two groups: observers and launchers. All students should wear safety goggles.
  - b. Assign students in pairs, one from each group.
  - c. Have the two groups line up on opposite sides of the room. This system works best in a large area, such as a gym, a hallway, or a lunchroom, with ample space for children to try to make the FPG-9 loop.
  - d. Direct the launchers group to prepare their gliders for flight. Remind students not to aim toward anyone but to point the gliders toward the landing area. Direct students to wait for your "3, 2, 1,

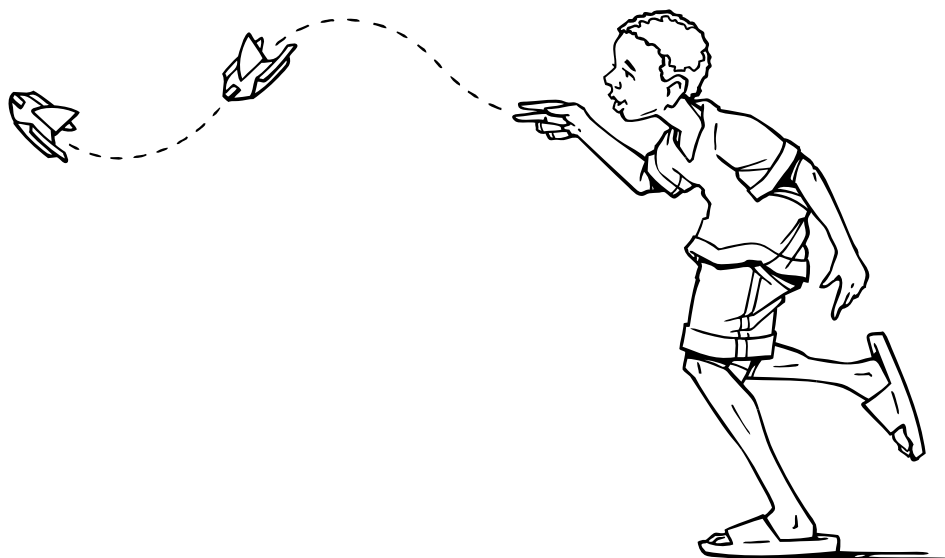

**Pitch Throw**

launch!” command and to remain in the launch area to watch as the gliders are propelled into the air. Give an “all clear” command to allow the observers group to enter the launch area to measure flight distances.

- e. Student pairs should collaborate to record how their gliders moved, and how far they traveled, on their worksheets.
- f. Repeat the procedures with the other half of the class from the opposite side of the room. Students who were observers are now launchers, and vice versa. Students can complete the investigation in a safe manner by taking turns this way.

**13. Student Launches:** The FPG-9 glider is complete and ready to fly. The first step to flying the glider is to **trim** it to fly in a straight path. Trimming is a method of making small adjustments on a model to make it fly in a controlled manner. Instruct students to hold one arm straight above their heads and gently toss the plane directly in front of them. They should be careful not to aim toward any person. After they observe how the glider flies, instruct students to make small adjustments to the elevons and the rudder until their gliders fly in a straight path. Show students how to make minor changes by bending the elevons, rudder, or tail. Have them repeat

the flight and observe ways the gliders moved differently. Students may need three tests flights to trim their glider to fly in a straight path. All three control surfaces (right elevon, left elevon, rudder) should be neutral — in line with the wing and tail. Have students explain how each force of flight is involved in a glider’s flight.

**14. FPG-9 Glider Flight Trials:** Once a glider is trimmed and flies in a straight path for a distance of several feet, instruct the students to perform the following three flight trials with elevons or rudders and record their observations on the Flight Research Card:

- a. **Pitch** — Refer students to the drawings at the bottom of the Flight Research Card. Hold up a glider with the nose facing away from you. Show students how you are now looking at the back of the airplane tail. Tilt the nose of the glider up and then down. Explain that this movement is called **pitch**. Have all the students repeat the word while making pitch movements with their gliders. Pitch is the up and down movements an aircraft makes in flight. The nose pitches up when climbing and pitches down when descending.
- b. **Pitch Up** — Ask students how they could get their FPG-9 to pitch up. Which control surface would have

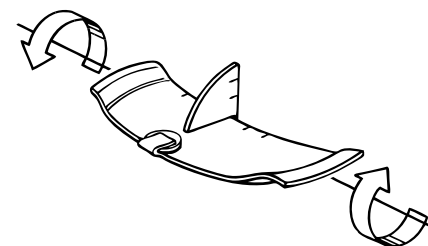

**Pitch**

to be adjusted and how? Then, have students test their ideas. [NOTE: It is better to make small adjustments rather than large ones.] Determine which students’ adjustments resulted in pitch up (bending both elevons up). Then have all students demonstrate pitch up. Some students will bend the elevons at almost a 90-degree angle. Instruct one of those students to point his or her glider with the nose facing away, tilted slightly upward, and not aimed toward anyone, and then to throw the glider with great force. Ask the class to observe how the glider moves. The FPG-9 should perform a big loop and have enough speed for a glide of 6 to 10 meters after the loop. Instruct the class to adjust the bend in their elevons just a little and then launch their gliders with the same amount of force and at the same angle for each step in this activity. They should repeat the trial until they achieve the intended effect.

- c. **Pitch Down** — Ask students how they think they could get their gliders to pitch down. Which control surface would have to be adjusted, and how? Have students test their ideas. Ask students whose adjustments resulted in pitch down (bending both elevons down) to show the class what they did. Then have all students make similar adjustments and launch their gliders again. The gliders should make a steep downward dive to the floor and not travel far.
- d. **Roll Right** — While holding the glider with the nose facing away from you, ask students to imagine a rod running through the glider from the nose to the tail. Rotate the glider around the axis of

*Continued on page 46.*

## Lesson Three

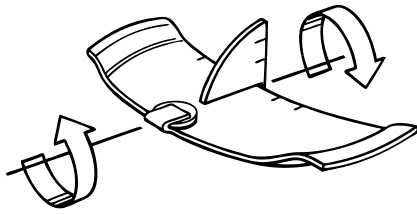

Roll

that imaginary rod. Tell the students that when a plane moves like this it is called **roll**. Instruct students to move the right elevon located on the wing up a small amount. The elevons and ailerons are interconnected: when one goes up the other goes down. Tell students to move the left elevon down a little. The tail rudder should be neutral. This should cause the plane to roll right. Ask students to observe how the glider moves. Tell students to make minor adjustments if the glider did not roll right.

- e. **Roll Left** — Instruct students to put the right elevon back to level with the wing, then move the left elevon down and the rudder to the left. This configuration should cause the plane to roll left. Ask students to observe how the glider moves. Tell students to make minor adjustments if the glider did not roll left.
- f. **Yaw** — Demonstrate yaw by holding the glider and moving it side to side while keeping it horizontal to the floor. Instruct students to hold their gliders and demonstrate yaw, roll, and pitch. Tell students that these are the basic ways an aircraft can move while flying. Moving the elevons and rudder is a way to control the flight of an airplane. The Wright brothers were early aviators who learned how to control the flight of an airplane by moving the control surfaces on the plane.

15. Identify the two **elevons** on the wings and label them with a ballpoint pen. They are control surfaces for the glider. Gently bend the elevons on the wing upward to provide for a small climb at launch and a longer

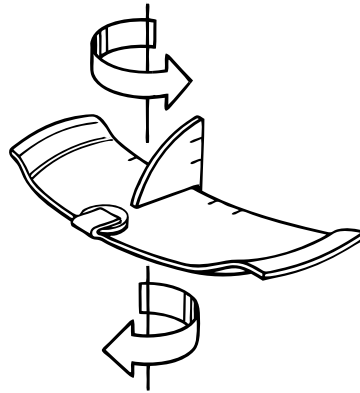

Yaw

glide. Students may benefit by putting two arrows on the wings of the airplane that point in the direction it will fly.

16. Identify and label the one **rudder** on the vertical **fin** (tail) of the glider. This is another control surface for the glider.
17. Show the Total Control video to your class. Discuss how an aircraft can be controlled. Use the FPG-9 as an example of the three ways an aircraft can move: **pitch**, **roll**, and **yaw**.
18. **Control Surfaces:** Ask students to add elevons (2) and a rudder to their model. Once they add the control surface, have them complete the trials and record their observations on the Flight Research Card.

### Sense-Making Discussion and Questions:

After completing their trials, ask students to review which control surface resulted in each motion of the FPG-9 (pitch, roll, and yaw). Then ask: What were the control surfaces on your aircraft? What are the functions of these control surfaces? How did the control surfaces affect the flight of your airplane? Were you able to make your FPG-9 fly in a predictable path? How? Why did changing the position of the control surface change the way your model flew? How could a model be useful for learning about how a full-size aircraft flies?

Guide students to explain that the model FPG-9 had special parts called control surfaces that interacted with air as it passed over them to

change the motion of the model. When the control surfaces were moved into the airflow it changed the motion of the aircraft in predictable ways. Explain that understanding how each control surface changes an aircraft's motion allows pilots to control how aircraft move.

Ask: How did the model you made help you understand how things fly? How was the model not helpful?

### Experience Assessment

Ask students to answer the following application question:

NASA engineers worked on the F-15 to improve control. Using what you have learned in your investigations, explain how the F-15 controls pitch, roll, and yaw.

### NASA Aeronautics Student Reports

Aircraft models have been tested in wind tunnel facilities at NASA Langley, NASA Ames, and NASA Glenn research centers and NASA Dryden Flight Research Center. Wind tunnels at NASA Marshall Space Flight Center have been and continue to be used to develop launch vehicles. Teachers may want to assign a student research report about one of the following:

- Wright brothers
- Control surfaces: canards, elevons, rudder, flaps, ailerons
- NASA Langley Research Center
- NASA Dryden Flight Research Center
- NASA Ames Research Center
- NASA Glenn Research Center
- NASA Marshall Space Flight Center
- NASA Career: Research Pilot
- NASA Fact Sheet: F-15

Information can be found at [nasa.gov](http://nasa.gov)

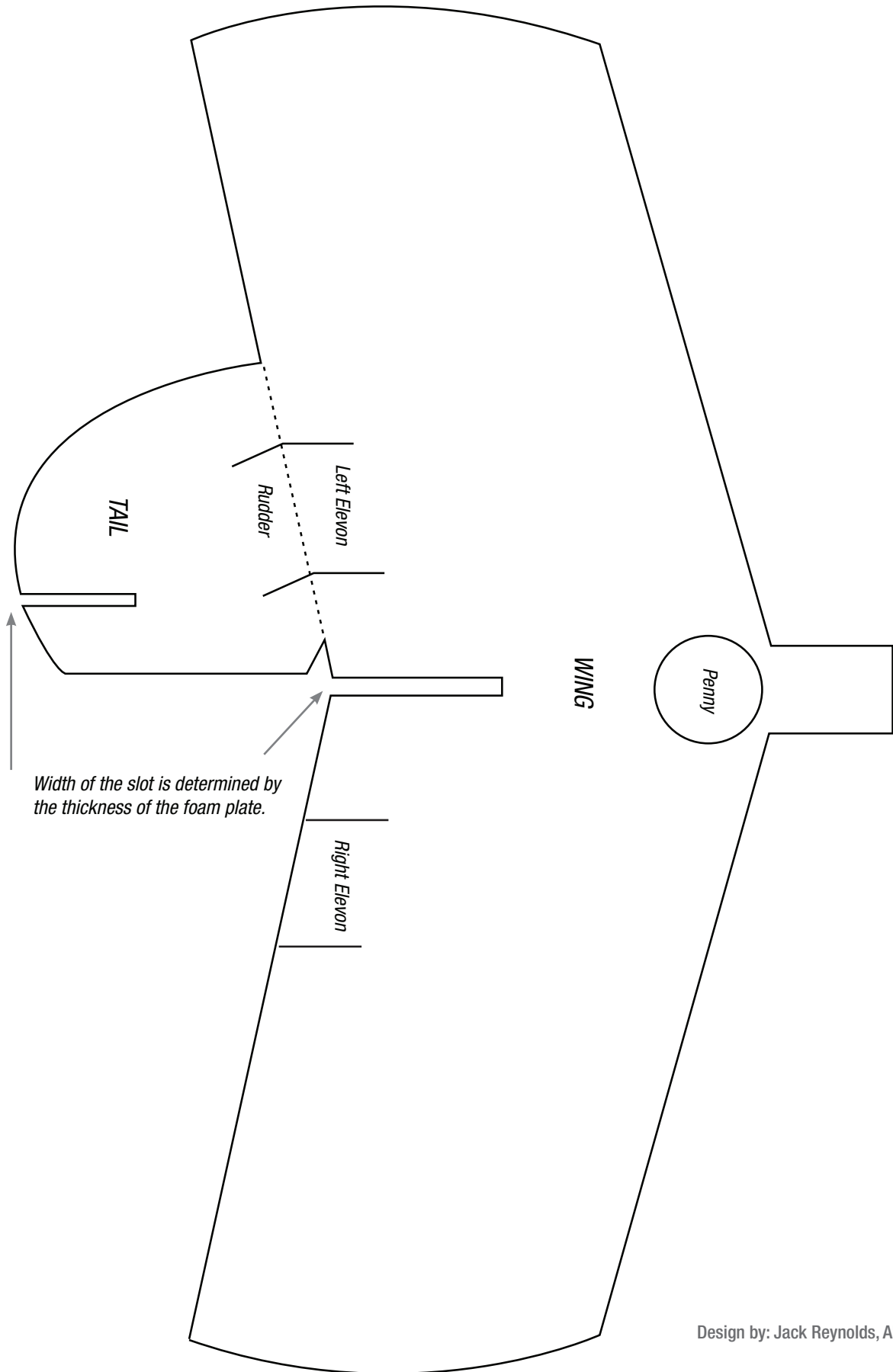

Design by: Jack Reynolds, AMA

**Curious Scientific Investigators**

**Flight Research Card • FPG-9 Glider • CSI Flight Adventure**

Name: \_\_\_\_\_ Date: \_\_\_\_\_

When your FPG-9 Glider is built and ready to fly, complete the following flight trials and record your observations.

<b>Flight Trials</b>	<b>Control Surface</b>	<b>Describe How the FPG-9 Flies</b>
1. Trial Flight	Control surfaces neutral	
2. Trial Flight	Control surfaces neutral	
3. Trial Flight	Control surfaces neutral	
4. Pitch Up	Elevons slightly bent up, rudder flat	
5. Pitch Down	Elevons slightly bent down, rudder flat	
6. Roll Right	Right elevon up, Left elevon down	
7. Roll Left	Left elevon down, Right elevon up	
8. Yaw Right	Rudder right	
9. Yaw Left	Rudder left	
10. Loop	Elevons up, hard throw to the ground	

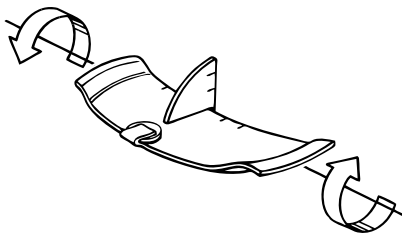

*Pitch*

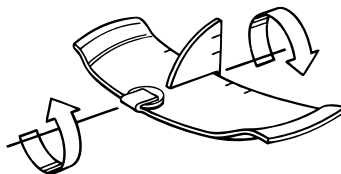

*Roll*

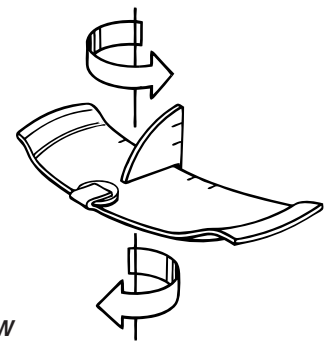

*Yaw*

Explain how the control surfaces on the FPG-9 cause it to move in different directions.



## NASA Fact Sheet: F-15

Read about the F-15 and answer the following Sense-Making Question: Using what you have learned in your investigations, explain how the F-15 controls pitch, roll, and yaw.



Sporting brilliant red, white and blue plumage, this highly-modified F-15B (Serial #71-0290) is being flown in the Advanced Control Technology for Integrated Vehicles (*ACTIVE*) research program at NASA's Dryden Flight Research Center in Edwards, California.

NASA PHOTO / JIM ROSS

### F-15 with movable canards

Dryden Flight Research Center tested the F-15B in 1993. McDonnell Douglas made this airplane for the U.S. Air Force. The F-15B served as a test aircraft for many programs at Dryden. Small wings called **canards** were tested on the front of the plane.

### F-15 Flight Research

Flight research carried out by NASA with an F-15 aircraft helped design better engines and systems of control. The F-15 is used to test flight safety and fuel efficiency. NASA's highly modified F-15, used for research, has an F-18 chase plane that observes the test plane and provides information to the pilot.



NASA's highly modified F-15 (left), used for digital electronic flight and engine control systems research, is accompanied by an F-18 chase support aircraft during its takeoff roll on a flight from the Dryden Flight Research Center in Edwards, California.

NASA PHOTO / JIM ROSS

View videos about the F-15 at

[childrensmuseum.org/  
flightadventures](http://childrensmuseum.org/flightadventures)

More information, including reference material, is available at [nasa.gov/  
centers/dryden/history/pastprojects/  
Active/index.html](http://nasa.gov/centers/dryden/history/pastprojects/Active/index.html)

### NASA Career: Research Pilot

After you build and test your FP69 model, learn how a NASA research pilot tests NASA aircraft. Read about a Research Pilot and answer the following Sense-Making Question: How does a Research Pilot help with a NASA mission?



Kelly Latimer is a research pilot in the Flight Crew Branch of NASA's Dryden Flight Research Center in Edwards, Calif. Latimer joined NASA in March 2007.

NASA PHOTO / TONY LANDIS



In August 1947, Howard Clifton Lilly became the first permanently assigned NACA engineering test pilot at the National Advisory Committee for Aeronautics' Muroc Flight Test Unit at what later became Edwards Air Force Base in California.

NASA PHOTO

Research pilots at NASA Dryden Flight Research Center are qualified, or rated, to fly several different types of aircraft. They are assigned as project pilots on more than one research project. Being a NASA research pilot is challenging, demanding, and occasionally risky. There are few occupations to which the job can be compared. The rewards of being a research pilot are generous. Research pilots have helped make almost every plane safer to fly.

NASA research pilots do more than fly. The education, training, and skills make them aerospace engineers. Pilots help with vehicle design and almost all parts of aircraft research. A NASA research pilot must have a degree in engineering, physical science, mathematics, or computer science. Some pilots have graduated from military or other test pilot schools. A NASA research pilot must also possess a current Federal Aviation Administration (FAA) commercial pilot license or be an active-duty military pilot.

Learn more about a research pilot by watching an interview at [childrensmuseum.org/flightadventures](http://childrensmuseum.org/flightadventures)

**Culminating Experience and Assessment**  
**Design, Build, Test, and Fly a Model**

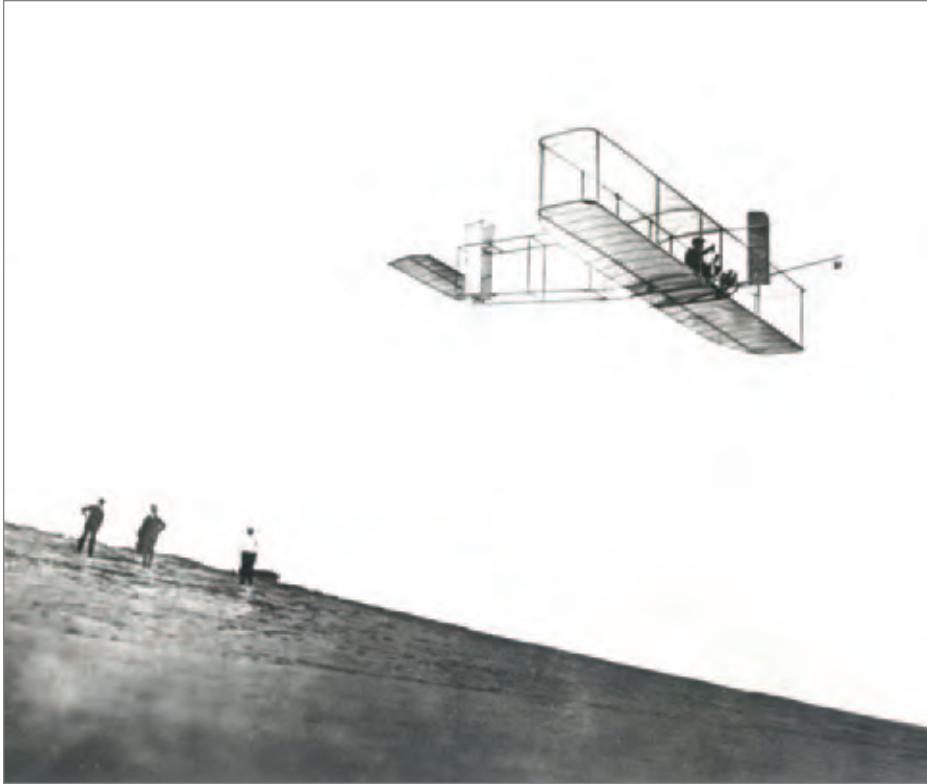

A photograph of Orville Wright in his glider at Kitty Hawk, North Carolina, in 1911. On October 24, 1911, Orville tested a new glider and broke all the previous gliding records by actually soaring and staying in flight for 9 minutes and 45 seconds. His record lasted for over a decade.

NASA PHOTO

**Overview**

In this culminating experience students apply what they have learned during the unit of study. They design, build, and test their models to accomplish their selected Flight Challenge. Students will use the models to conduct a series of trial flights, recording information on the Flight Research Card. The models should demonstrate concepts learned in the unit of study and be connected to a NASA project.

**Background**

**NASA Website for Students: Future Flight**

<http://futureflight.arc.nasa.gov/welcome.html>

**Objectives**

**Each student will:**

- design, build, and test a model aircraft to demonstrate a concept related to flight;
- present the results of the flight trials in an oral presentation; and
- make connections between his or her model and a NASA project.

**You Will Need**

**Materials**

- Student Handout
  - Flight Research Card
- Foam Plates
- Foam meat plates
- Pennies
- Tape
- Thread
- Straws
- Paper
- Balsa wood sheets and sticks
- Coffee stir sticks
- Foam cups
- Paper clips
- Other craft material
- Goggles

**Time:** 60 to 90 minutes



This biplane glider was designed in 1896 by Octave Chanute, a civil engineer who was the most serious student of aeronautics in the U.S. before the Wrights began their work.

PUBLIC DOMAIN / WIKIPEDIA

### Early Models: Birds, Kites, and Gliders

Models representing the history of flight from early Egypt to the present day may include an Egyptian bird model, a Chinese flying top, Leonardo da Vinci's helicopter and parachute, Cayley's glider, a twirling "wind tunnel," Penaud's Planophore, the Wright brothers' kite, and wind tunnel model airfoils. Although the Wright brothers never considered Daniel Bernoulli's theory when inventing the first flying machine, it was generally understood by those investigating flight in the late 19th century that cambered (curved) wings were more efficient than flat wings. Bernoulli, whose work was based on Newton's, observed that the pressure of a fluid is lower when it is moving faster. This means that slower moving fluids have higher pressure. In general, Bernoulli's Principle applies to flight in the following way: Air passes faster over the top of a cambered wing, resulting in lower pressure. Therefore, cambered wings lift more easily than flat wings. In addition, camber reduces drag, having another positive effect on lift. Many of today's textbooks and general references incorrectly credit Bernoulli's Principle as the only explanation of lift, an explanation that is incomplete. Newton's Third Law of equal and opposite forces must also be considered. A wing (cambered or flat) also deflects air downward because of its angle of attack, creating the reaction force of lift. Other historic models may include:

- Benjamin Robins — Whirling Arms, predecessors to the wind tunnels
- Sir George Cayley — Whirling Arm to test airfoils
- Sir George Cayley — Kite Skimmer
- Otto Lilienthal Glider
- Wright brothers — The Bat
- Wright brothers — Kite
- Wright brothers — Glider
- Wright brothers — Wright Flyer

## Procedures

### Flight Challenge

1. Pass out the student handout for this experience found on page 53.
2. Students will select one of the following Flight Challenges for their project.
  - a. Make a loop
  - b. Make a right turn
  - c. Make a left turn
  - d. Fly 5 meters in a straight path
  - e. Other selection
3. Students will review what they learned in the previous lessons that can be applied to their Flight Challenge.
4. Students will design, build, test, and fly their own aircraft models using a variety of materials provided.
5. Students will create trial tests using the Research Flight Card format.
6. Each student will present an oral report that explains his or her
  - a. Flight Challenge
  - b. model design
  - c. trial test — Flight Research Card
  - d. examples of how the model demonstrates what was learned in the unit
  - e. examples of how the model demonstrates a NASA project
7. Encourage students to evaluate their designs based on the Flight Research Card. They should revise their designs to improve success.

**Provide time for students to share their designs and models with the class.**

**Teachers may provide an additional Flight Research Card for the new model.**

### Modeling at an Early Age ...

- Orville and Wilbur Wright's father gave his children a rubber-powered model in the late 1870s called *The Bat*.
- Burt Rutan, the designer of the first private space craft, began modeling at age 6.
- AMA Ambassador and five-time space shuttle commander, Robert "Hoot" Gibson, began modeling at age 8.

**Curious Scientific Investigators**

**Flight Research Card • Flight Challenge • CSI Flight Adventure**

Name: \_\_\_\_\_ Date: \_\_\_\_\_

**Select a Flight Challenge:**

- Make a loop
- Fly 5 meters in a straight path
- Make a right turn
- Other selection: \_\_\_\_\_
- Make a left turn

Design an aircraft: list the materials and make drawings

Conduct Launch Trials	Record the Distance, Path, and Flight Observations
<b>Launch 1</b>	
<b>Launch 2</b>	
<b>Launch 3</b>	
<b>Launch 4</b>	
<b>Launch 5</b>	

What flight concept from the unit does your model show?

### Extending the Experience: Jetstream Tethered Model

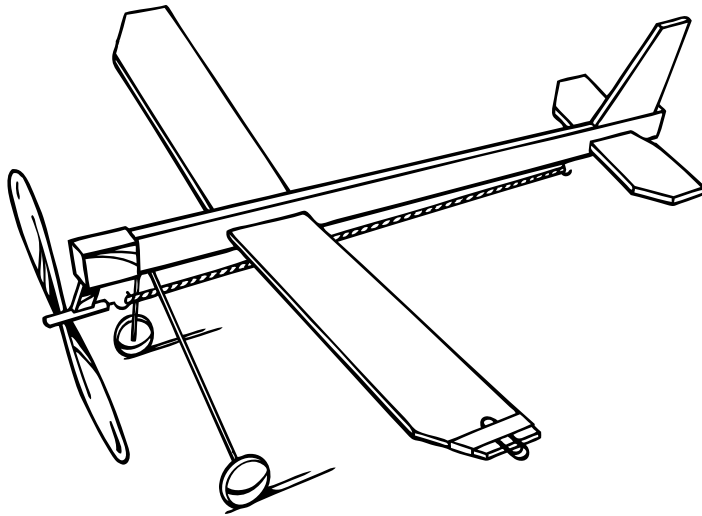

#### Overview

The Jetstream demonstration is a challenging lesson because it involves the construction of a rubber-band-powered balsa aircraft. Teachers may want to enlist the help of local AMA clubs or students in their class to build the Jetstream. Because this experience is a teacher demonstration extension, some new materials and additional preparation are required to make the activity successful. However, preparing for this demonstration can be easy because every class has a number of students who are eager and willing to become a member of a “CSI Flight Research Team.”

As with all previous experiences in this unit, **it is highly recommended that teachers preview the video segments before class and then use them in the presentation of each lesson.**

**Website:** [childrensmuseum.org/flightadventures](http://childrensmuseum.org/flightadventures)

To do the experience, teachers should first order a few airplanes, one or two winders, and some special rubber strips used for motors to ensure long flights. These materials are readily available by contacting model supply sources listed in the resources section on page 62.

#### Teacher Tip: Jetstream Tethered Model Trial Flight Problems and Cures

Flight Path	Correction
Flies straight, glides smoothly	No changes needed
Dives down	Move wing forward 1/8 inch
Dives up	Move wing back 1/8 inch

#### Objectives

In this experience, teachers will ask for student volunteers to

- assemble and test fly the Jetstream model aircraft; and
- learn how to manipulate two variables (added weight and drag) to demonstrate how the aircraft changes.

#### You Will Need

##### Materials

- Student Handout
  - Flight Research Card
- Two or more Jetstream airplanes to allow for breakage as well as extra parts
- Pylon system
- Stopwatch
- Masking tape
- Several coins
- Yarn
- Website: [childrensmuseum.org/flightadventures](http://childrensmuseum.org/flightadventures)

**Time:** 60 minutes

#### Key Terms

propeller  
fuselage

#### Online Support

This teacher/student demonstration has several online video components that are suitable for teachers and CSI Flight Team background information that eventually can be viewed by all students in the class as an introduction to the demonstration. The lesson extension is designed to be complete as written. **However, it is highly recommended that teachers preview the videos prior to class and then use the video segments in the presentation of the demonstration.**

**Website:** [childrensmuseum.org/flightadventures](http://childrensmuseum.org/flightadventures)

**Video:** *Jetstream — Teacher Demonstration*

## Background

The Jetstream model is a simple rubber-band-powered aircraft. The model has a plastic propeller and wheels and is easy to assemble for use in demonstrating the effects of weight and drag for younger students. Unlike the experiences with the FPG-9, which is a free-flight model, flying the Jetstream from a tethered pylon allows for an accurate demonstration to determine how forces act upon a flying aircraft. Flying the airplane in a controlled setting is much like a simple wind tunnel, making it possible to show how relatively minor changes can be made to affect the aircraft's performance. This experience is similar to how NASA historically used control-line models to test aircraft designs. Students will make observations about how modifying the model (adding weight and drag) affects how Jetstream flies. (Read more about wind tunnels on page 60.)

The purpose of this demonstration is to have students observe how the four forces of flight are affected by added weight and drag, two of several important variables that must be controlled to enable successful flight. Lift is generated to overcome the weight of the plane and thrust to move forward and overcome drag. The entire experience is designed as a teacher-directed, student-assisted flight demonstration. Assuming that the CSI Flight Team has assembled the plane and pylon, and flight-tested the plane in advance, the first part of this demonstration will take little more than 15 minutes. However, if teachers wish to offer other students an opportunity to fly the airplane, time for this extension experience could take as much as 45 minutes.

## Procedures

1. **Assembling the Jetstream.** Carefully open the package and remove the airplane parts.
  - a. Inventory the parts of the Jetstream: horizontal stabilizer, vertical fin, motor stick (**fuselage**), **propeller** mount,

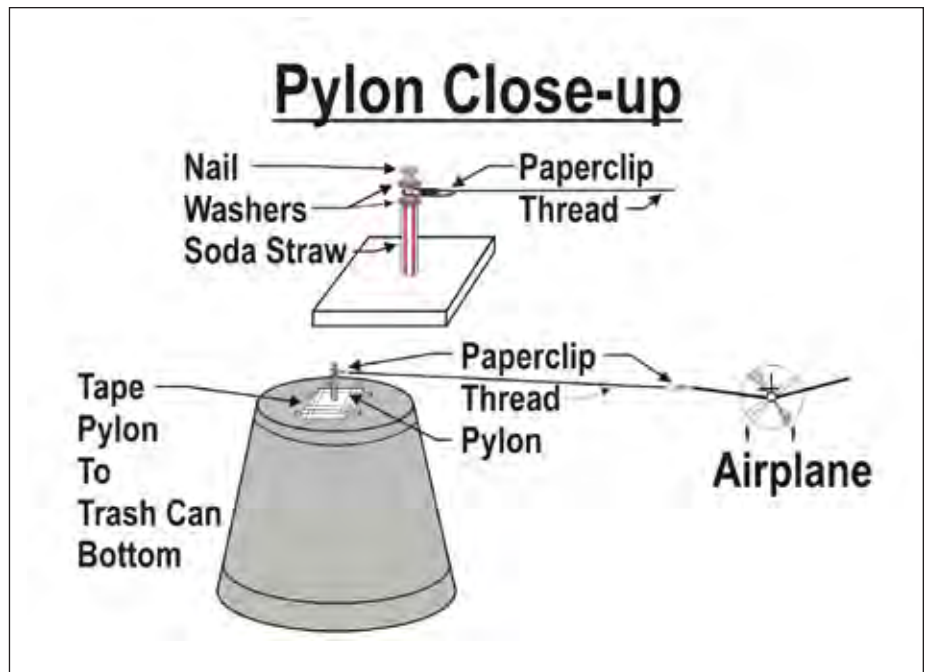

- b. Unwind the landing gear legs and wheels.
  - c. Insert the metal landing gear legs into the plastic propeller mount.
  - d. Insert the assembled landing gear/propeller mount into the motor stick with the pilot slit up and the metal hook on the bottom.\* The rubber-band motor goes on the bottom.
  - e. Slide the wing into the slot of the motor stick. Move it gently to the center.
  - f. Insert the horizontal stabilizer.
  - g. Insert the vertical fin.
  - h. As demonstrated in the video, cut a 23" length of the special tan rubber and tie two knots at the end. A small amount of all-purpose lubricant available from any hardware or convenience store will increase the life and power of the rubber. Place the knotted end of the rubber band at the back hook, by the tail of the Jetstream. The rubber band will loop down a bit.
  - i. As shown in the video, add a paper clip to the left lower end of the wing. Tape it in place.
  - j. Add another piece of tape to the opposite side of the wing near the motor stick, as shown in the video.
- \*Add one drop of super glue. Use caution with super glue. Students should not work with it.
2. **Building the Pylon.** Use the diagram above to assemble the pylon. All of the materials are provided.
    - a. Inspect the materials — block of wood, nail, washer, paper clip, washer, straw.
    - b. Place the block of wood on the table.
    - c. Assemble the nail mount by adding in this order: washer, paper clip, washer, straw.
    - d. Teachers should pre-drill a hole for the nail to make an easy fit without splitting the block of wood.
    - e. Gently tap the nail and the assembled parts into the hole in the wood block.
    - f. Tie the thread to the paper clip on the pylon
    - g. Attach the other end of the string to the paper clip on the wing.



**Stopping Point.**

You can split the lesson here.

## ▶ Extending Experience

**3. Launching the Jetstream.** When the pylon is complete, find an area wide enough for the airplane to fly in a circular path. The following is an effective way to conduct Jetstream flight trials:

- The plane is flown counterclockwise from a paper clip attached to the inboard wing.
- The winding process is always done with the plane inverted, with the rubber motor always parallel to the fuselage and stretched to about a meter and a half for 700 winds.
- The winder should always be held in line with the motor (not at an angle, which will break the motor and unnecessarily tax the winder).
- Walk slowly toward the model for the final 200 winds.
- Release the winder and attach the motor to the hook as demonstrated in the video.

**4. Trimming the Jetstream.** The Jetstream is complete and ready to fly. The first step on flying the plane is to make sure it is properly trimmed, or set to fly in a level path.

**5. Jetstream Flight Trials.** Distribute the student handout for this experience found on page 53 of the unit. Once a Jetstream is trimmed and flies in a level path, demonstrate it to your students. Teachers and students can use a Jetstream model to demonstrate how forces affect flight. The CSI Flight Research Team can make a variety of changes to the model by adding drag, decreasing the circumference, or adding more winds to the motor to add power. **Additional information on how to assemble and launch the model properly and how to attach weight and yarn for drag to demonstrate their effects on performance can be found in the video segments.**

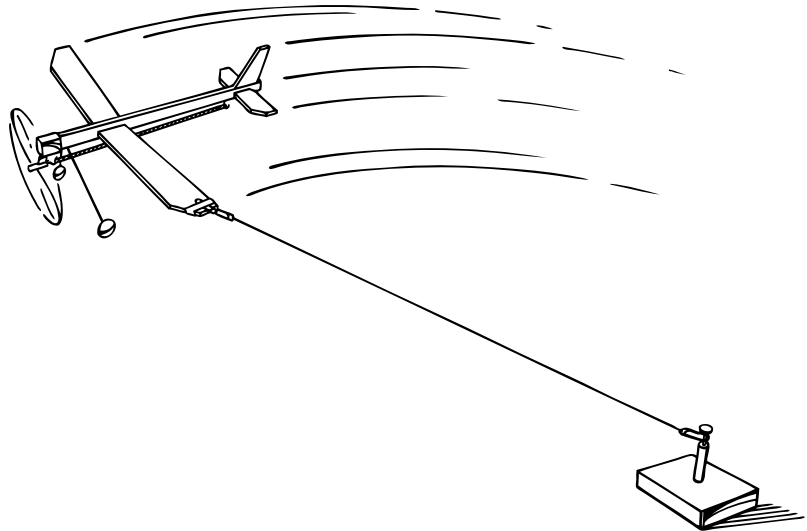
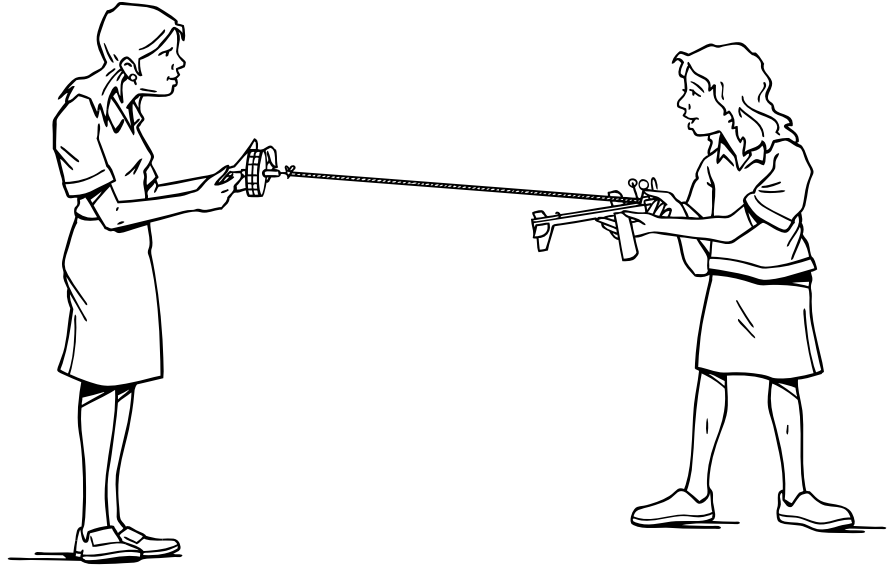

**6. CSI Flight Research Team.** The CSI Flight Research Team must assemble and test the plane and pylon. When ready for the demonstration, teachers should ask the team to begin by flying the airplane first without any modifications. Following a few successful flights, teachers can pose these questions:

- What do you predict will happen if I tape these coins to the wing? (The result will be a clear demonstration of the effects of weight on aircraft performance).
- What will happen if I add yarn to each wingtip? (The result will be a good demonstration of drag.)

The only calculations students will make are timing the duration of flight and the distance the Jetstream flies from takeoff to touchdown. Have students use the Flight Challenge student handout on page 53 to report findings.



**Curious Scientific Investigators**  
**Science Journal**

Name: \_\_\_\_\_ Date: \_\_\_\_\_

Project name: \_\_\_\_\_

**Notes:** \_\_\_\_\_

\_\_\_\_\_

\_\_\_\_\_

\_\_\_\_\_

\_\_\_\_\_

\_\_\_\_\_

\_\_\_\_\_

\_\_\_\_\_

\_\_\_\_\_

\_\_\_\_\_

\_\_\_\_\_

**Drawings and Observations:**

\_\_\_\_\_

\_\_\_\_\_

\_\_\_\_\_

\_\_\_\_\_

\_\_\_\_\_

\_\_\_\_\_

\_\_\_\_\_

\_\_\_\_\_

\_\_\_\_\_

\_\_\_\_\_

\_\_\_\_\_

### An Inquiry-Based Experience for All

If, after completing the demonstration experience, teachers wish to provide students with an inquiry-based activity, divide the class into teams of three or four. Provide each group with spare parts from other Jetstream kits or pieces of balsa (available at model shops or most hardware stores). Challenge the students, based on what they have learned in all of the lessons, to create a design of their own. The team that designs the fastest (or slowest) airplane wins. Students may decide to clip the wings, eliminate some or all of the “tail feathers” or the landing gear to reduce weight and drag — whatever works for them. Engineers are often inspired by early hands-on activities such as these. This experience could open doors to creative thinking for all students.

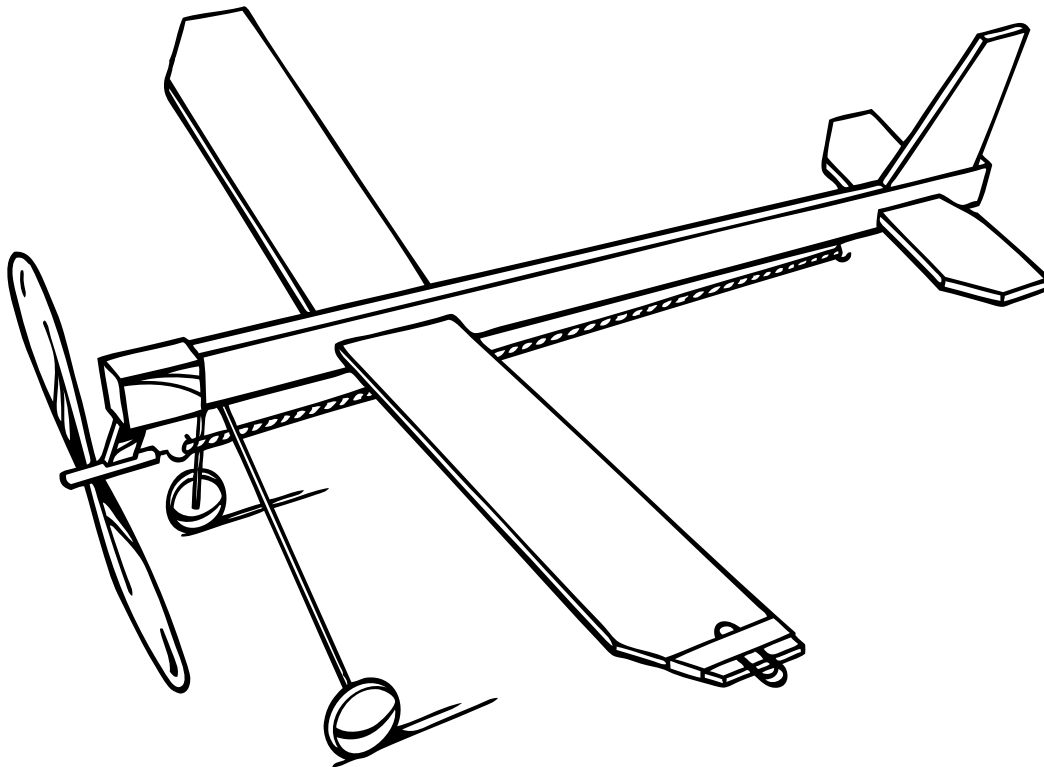

### NASA website: Beginner's Guide to Wind Tunnels



A model of the Space Shuttle in the 16-foot Transonic Wind Tunnel at NASA Langley Flight Research Center.

NASA PHOTO

What is a wind tunnel? How do aerospace engineers use wind tunnels? A wind tunnel is a machine that can simulate the movement of air around an aircraft in flight. In the wind tunnel, the aeronautical engineer can control the conditions that affect the forces and motion of the aircraft. By making careful measurements of the forces on a model of the aircraft, the engineer can determine the magnitude of the forces on the real, full-size aircraft. The wind tunnel model can also be used for diagnostics to make a detailed determination of how the air moves around the aircraft.

[www.grc.nasa.gov/WWW/K-12/airplane/bgt.html](http://www.grc.nasa.gov/WWW/K-12/airplane/bgt.html)



A scale model of the ARES being tested in the Langley Research Center Transonic Dynamic Tunnel. This model has the wings and tail in their fully developed positions.

NASA PHOTO

*Continued on page 60.*

*Continued from page 59.*

**NASA Website: Beginner's Guide to Wind Tunnels**

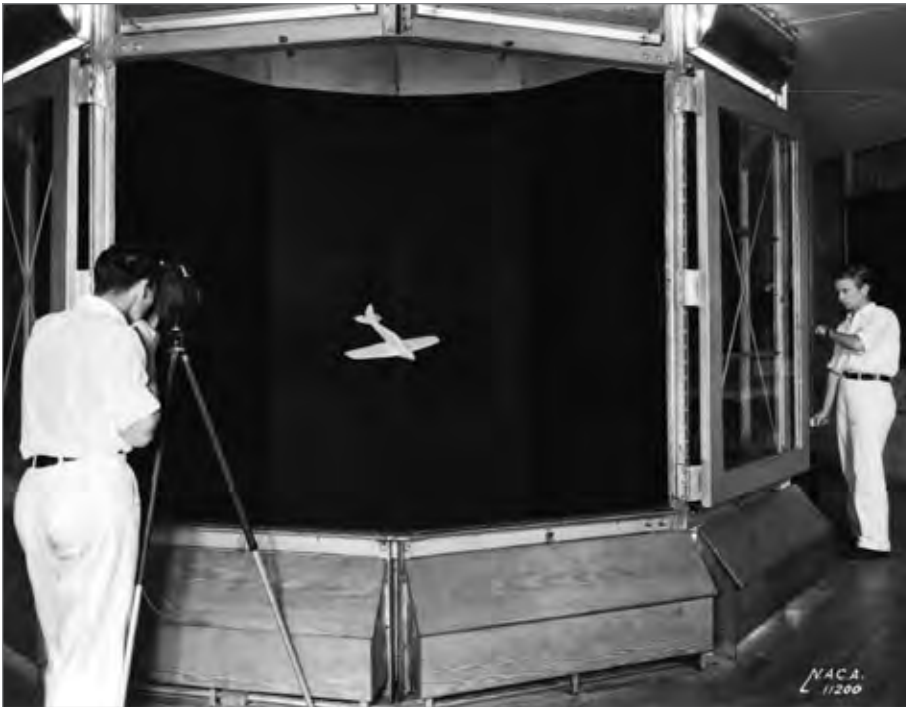

NASA Langley 15-Foot Spin Tunnel, 1935.

NASA LANGLEY RESEARCH CENTER

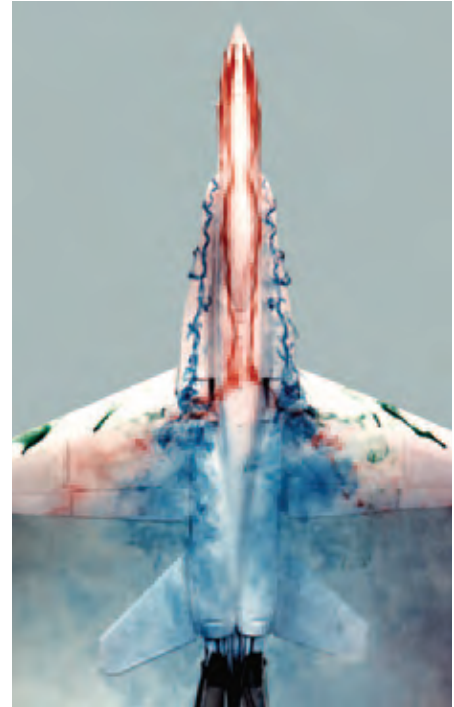

This image shows a plastic 1/48-scale model of an F-18 aircraft inside the “Water Tunnel” more formally known as the NASA Dryden Flow Visualization Facility. Water is pumped through the tunnel in the direction of normal airflow over the aircraft. Then, colored dyes are pumped through tubes with needle valves. The dyes flow back along the airframe and over the airfoils, highlighting their aerodynamic characteristics.

NASA PHOTO



On Dec. 17, 1903, the Wright brothers made the first powered flight. In March 1999, a full-scale replica of the 1903 Wright Flyer was mounted in NASA Ames Research Center's 40-by-80-foot wind tunnel for tests to build a historically accurate aerodynamic database of the Flyer.

NASA PHOTO

## Curious Scientific Investigators (CSI): Flight Adventures at The Children’s Museum of Indianapolis

The CSI: Flight Adventures project is designed to immerse visitors in a variety of activities, programs, and interactive displays. A special website offers additional information and resources for this unit of study:

[childrensmuseum.org/flightadventures](http://childrensmuseum.org/flightadventures)

Visitors to the site can find information on the following:

- CSI Flight Adventures Unit of Study, Grades 3–5
- CSI Flight Adventures Unit of Study Training Videos
- CSI Flight Adventures Journal Template
- CSI Flight Adventures Multimedia Planetarium Show
- *Wings Over Indiana*, a WFYI/PBS Television Documentary
- Interactive Displays: Vertical Wind Tunnel, Flight Simulators
- Artifact Displays from NASA centers and the Academy of Model Aeronautics
- Online Learning Module and Inquiry Investigation
- Live Theater Interpretation
- Family Programs
- Teacher Professional Development
- School Programs
- Preschool Programs
- Community Programs and Events
- The Museum Apprentice Program

## Websites for Students

### The Children’s Museum of Indianapolis CSI Flight Adventures!

[childrensmuseum.org/flightadventures](http://childrensmuseum.org/flightadventures)

#### NASA: Beginner’s Guide to Kites

[www.grc.nasa.gov/WWW/K-12/airplane/bgk.html](http://www.grc.nasa.gov/WWW/K-12/airplane/bgk.html)

Teaches basic math and physics that govern their design and flight.

#### NASA: The Beginner’s Guide to Rockets

[www.grc.nasa.gov/WWW/K-12/rocket/bgmr.html](http://www.grc.nasa.gov/WWW/K-12/rocket/bgmr.html)

Teaches basic math and physics that govern the design and flight of rockets

#### NASA: Beginner’s Guide to Wind Tunnels

[www.grc.nasa.gov/WWW/K-12/airplane/bgt.html](http://www.grc.nasa.gov/WWW/K-12/airplane/bgt.html)

#### NASA — Careers

[nasa.gov/audience/forstudents/careers-index.html](http://nasa.gov/audience/forstudents/careers-index.html)

Employment and internship information, listed by grade level

#### NASA Quest Challenges

<http://quest.nasa.gov/index.html>

Interactive explorations for students.

#### NASA: Re-Living the Wright Way

[www.grc.nasa.gov/WWW/Wright/index.htm](http://www.grc.nasa.gov/WWW/Wright/index.htm)

A student guide to the accomplishments and history of the Wright brothers.

## Websites for Teachers

### Academy of Model Aeronautics (AMA)

[modelaircraft.org/education/edparket.aspx](http://modelaircraft.org/education/edparket.aspx)

#### NASA Education

[nasa.gov/offices/education/about/index.html](http://nasa.gov/offices/education/about/index.html)

#### NASA Aeronautics

[nasa.gov/topics/aeronautics/index.html](http://nasa.gov/topics/aeronautics/index.html)

#### NASA Aeronautics Education

[www.aeronautics.nasa.gov/education.htm](http://www.aeronautics.nasa.gov/education.htm)

#### NASA Aeronautics E-Books

[www.aeronautics.nasa.gov/ebooks/index.htm](http://www.aeronautics.nasa.gov/ebooks/index.htm)

#### NASA Ames Research Center

[nasa.gov/centers/ames/home/index.html](http://nasa.gov/centers/ames/home/index.html)

#### NASA: Courage to Soar

[nasa.gov/audience/foreducators/topnav/materials/listbytype/The\\_Courage\\_to\\_Soar.html](http://nasa.gov/audience/foreducators/topnav/materials/listbytype/The_Courage_to_Soar.html)

This site is an integrated unit of scientific experiments, aircraft models, and research topics about aviation.

#### NASA Dryden Flight Research Facility

[nasa.gov/centers/dryden/about/index.html](http://nasa.gov/centers/dryden/about/index.html)

#### NASA: Educator’s Guide to Rockets

[nasa.gov/audience/foreducators/topnav/materials/listbytype/Rockets.html](http://nasa.gov/audience/foreducators/topnav/materials/listbytype/Rockets.html)

A comprehensive guide to and history of rockets.

#### NASA: Flexible Wing Design Used for Hang Gliders

[nasa.gov/audience/foreducators/topnav/materials/listbytype/NASA\\_at\\_50\\_1961.html](http://nasa.gov/audience/foreducators/topnav/materials/listbytype/NASA_at_50_1961.html)

Video, audio, and teachers guide for hang gliders.

#### NASA: Future Flight

<http://futureflight.arc.nasa.gov/welcome.html>

#### NASA: Key Terms

[nasa.gov/audience/foreducators/nasaclips/toolbox/Key\\_Terms.html#f](http://nasa.gov/audience/foreducators/nasaclips/toolbox/Key_Terms.html#f)

#### NASA: Key Terms—Picture Dictionary

[nasa.gov/audience/forstudents/k-4/dictionary/index.html](http://nasa.gov/audience/forstudents/k-4/dictionary/index.html)

#### NASA Langley Research Center

[nasa.gov/centers/langley/home/index.html](http://nasa.gov/centers/langley/home/index.html)

#### NASA Marshall Space Flight Center

[nasa.gov/centers/marshall/home/index.html](http://nasa.gov/centers/marshall/home/index.html)

#### NASA: Modeling Flight

[www.aeronautics.nasa.gov/ebooks/index.htm](http://www.aeronautics.nasa.gov/ebooks/index.htm)

A comprehensive guide to and history of how models have been used to advance flight.

### Paresev

[nasa.gov/centers/dryden/multimedia/imagegallery/Paresev/Paresev\\_proj\\_desc.html](http://nasa.gov/centers/dryden/multimedia/imagegallery/Paresev/Paresev_proj_desc.html)

### Spacewedge

[nasa.gov/centers/dryden/news/FactSheets/FS-045-DFRC.html](http://nasa.gov/centers/dryden/news/FactSheets/FS-045-DFRC.html)

## Model Supply Links

### AC Supply

[acsupplyco.com/home.htm](http://acsupplyco.com/home.htm)

A comprehensive site of model supplies.

### DC Maxcutters Club

<http://dcmaxcutter.org/about.html>

One of the best-known free-flight clubs in the country.

### Dumas Products, Inc.

[dumasproducts.com](http://dumasproducts.com)

Dumas offers a line of laser-cut rubber scale kits.

### Sig Manufacturing Co., Inc.

[sigmfg.com](http://sigmfg.com)

Sig is the largest mail order business in the modeling field and has lots of items of interest to free flight fliers including scale and non-scale kits, tissue, wood, adhesives, and other supplies.

### National Free Flight Society

[freeflight.org](http://freeflight.org)

The Free Flight Society is a special interest group dedicated to the practice and promotion of free flight model flying.

### Don Slusarczyk's Indoor Free Flight

[indoorfreeflight.com](http://indoorfreeflight.com)

A site devoted to indoor flying. Lots of tips, plans, and information, including a new Science Olympiad CD-ROM.

## Organizations

**Academy of Model Aeronautics (AMA) — Education Through Aviation**  
[modelaircraft.org/education](http://modelaircraft.org/education)



The Academy of Model Aeronautics is the world's largest model aviation association, representing a membership of more than 140,000 men, women, and youths from every walk of life, income level, and age group. The Academy promotes the development of model aviation as a competitive sport, recreational hobby and educational pursuit. It charters more than 2,400 model airplane clubs across the country.

Key to the AMA's mission is introducing aeromodeling to students in both formal and informal settings, to augment curricula with experiential education linked to state and national standards in science, technology, engineering, and math (STEM), with a major emphasis on fun.

The headquarters for the Academy is at the International Aeromodeling Center, located near Muncie, Indiana, at an 1,100-acre site where thousands of modelers compete in national and international events each year. The Center is also home to the National Model Aviation Museum, where the history and development of model aviation is on display for the general public, classroom curricular enhancement, and those who do research on the development of model aviation as a sport and hobby.

The Education Department of the Academy has established collaborative educational relationships with the Experimental Aircraft Association and Civil Air Patrol. In addition, students nationwide are engaging in aerospace education through AMA's Model Aviation Student Club (MASC) program.

Many of the activities featured in this unit of study are drawn from extensive work that the Academy created for the 2003 Centennial of Flight celebration of the Wright brothers (Inventing Flight), as well as work funded by the Academy and the Alcoa Foundation to connect model aviation to state and national STEM standards (AeroLab) for use by the AMA's clubs and classroom teachers.

The Academy encourages educators to contact a local AMA club to arrange for a modeler to arrange a classroom presentation and possibly

an indoor or outdoor flying demonstration for the whole school. To find a club in your area, go to [modelaircraft.org/education](http://modelaircraft.org/education), click on "Find A Club" (at the bottom right), and fill in your school's ZIP code.

### Federation Aeronautics International (FAI) — Model Aircraft World Records

FAI dealt with aeromodeling for the first time at the 1935 Dubrovnik Conference, when the Aero Club of France proposed a first set of rules to cover national and international records. The first-ever world record (called international records at that time) to be recognized was a duration of 7 minutes and 36 seconds set by Gabriel Robert of France, on September 13, 1936. This record was set using a free-flight model with extensible motor in what was at that time 'Category A' (hand-launched models). Since then, hundreds if not thousands of world records have been set, pushing the capabilities of model aircraft beyond limits nobody could have dreamed of some decades ago. Model aircraft have flown for more than 30 hours, reached altitudes in excess of 8,000 meters, and covered distances of more than 1,300 km. <http://records.fai.org/models/>



The author preparing to launch his first model aircraft, in 1960.

**airfoil:** The shape of a wing or blade.

**camber:** The asymmetry between the top and the bottom surfaces of an aerofoil.

**canopy:** The fabric or material part of a parachute that captures air as it moves.

**control surface:** Any moveable part of an aircraft that the pilot can use to change the motion or direction of the craft.

**drag:** A force that opposes the motion of an object.

**elevon:** An aircraft control surface that combines the functions of an elevator and an aileron (a movable blade used to cause a rolling motion).

**fin:** A wing or blade attached to an aircraft for directional, such as a vertical stabilizer on a model airplane.

**flight:** The process in which an object heavier than air takes off and moves through the air.

**force:** An effect that pushes or pulls an object in motion or causes an object's motion to change speed or direction.

**fuselage:** the central section of an aircraft, such as the area in a plane where passengers sit.

**glider:** An aircraft without an engine.

**gravity:** The attraction between two masses.

**kite:** A tethered aircraft.

**lift:** A force that directly opposes the weight of a moving object and holds it up.

**mass:** The property of matter which gives it both inertia and weight.

**matter:** Anything that takes up space and has mass.

**mean:** The average number in a group of numbers.

**median:** The middle number in a set of numbers that have been arranged in order.

**mode:** The number that occurs most frequently in a set of numbers.

**model:** A representation of an object, system, or event in the real world. A model contains certain essential characteristics, but not every feature of that which is being depicted. Therefore, it is important to keep in mind how a model is different from its real world counterpart. A model may be a physical or symbolic representation.

**parachute:** A device used to slow down an object moving through the atmosphere.

**pattern:** A model of an original form, used to make a copy.

**parafoil:** A nonrigid airfoil with an aerodynamic cell structure which is inflated by the wind.

**pitch:** Movement of an airplane perpendicular to the longitudinal axis, usually termed "nose up" or "nose down."

**propeller:** A powered wing or a blade that spins and exerts a push or a pull force on the aircraft.

**pyramid:** A solid object with a square bottom and four sides that comes to a point at the top.

**range:** The difference between the lowest and the highest in a set of numbers.

**rocket:** An aircraft propelled by thrust.

**roll:** Movement of an airplane along the longitudinal axis, usually called "right/left roll" or "right/left bank."

**rudder:** A movable flight control surface hinged to the back of a vertical stabilizer, providing yaw control.

**shroud lines:** The lines on a parachute that suspend the harness from the canopy.

**surface area:** The measurement in square units of how much exposed area a solid object has.

**tail:** The back part of an airplane, typically stabilizing surfaces with attached control surfaces.

**thrust:** A force that propels an object in a given direction.

**trim:** An adjustment to a plane or a model plane for optimal flight.

**weight:** The force an object exerts due to gravity.

**wing:** The airfoil surface that produces the main source of lift for an airplane.

**yaw:** Movement of an airplane along the vertical axis, produced by the rudder.

## Indiana Academic Standards

### Science

This unit addresses Indiana Process Standards for The Nature of Science and The Design Process and integrates them with Content Standard 4: Science, Engineering and Technology.

#### Grade 3

3.4.1 Choose and use the appropriate tools to estimate and measure length, mass, and temperature in SI units.

#### Grade 4

4.4.1 Investigate transportation systems and devices that operate on or in land, water, air, and space and recognize the forces (lift, drag, friction, thrust, and gravity) that affect their motion.

4.4.3 Investigate how changes in speed or direction are caused by forces: the greater the force exerted on an object, the greater the change.

4.4.4 Define a problem in the context of motion and transportation. Propose a solution to this problem by evaluating, reevaluating and testing the design. Gather evidence about how well the design meets the needs of the problem. Document the design so that it can be easily replicated.

#### Grade 5

5.4.2 Investigate the purpose of prototypes and models when designing a solution to a problem and how limitations in cost and design features might affect their construction.

### English/Language Arts

#### Grade 3

3.2.7 Follow simple multiple-step written instructions.

3.4.4 Use various reference materials (such as a dictionary, thesaurus, atlas, encyclopedia, and online resources).

3.5.8 Write or deliver a research report that has been developed using a systematic research process (defines the topic, gathers information, determines credibility, reports findings) (Core Standard)

3.7 Students listen critically and respond appropriately to oral communication. They speak in a manner that guides the listener to understand important ideas by using proper phrasing, pitch, and modulation (raising and lowering voice). Students deliver brief oral presentations about familiar experiences or interests that are organized around a coherent thesis statement (a statement of topic). Students use the same Standard English conventions for oral speech that they use in their writing.

3.7.5 Organize ideas chronologically (in the order that they happened) or around major points of information. (Core Standard)

3.7.6 Provide a beginning, middle, and an end to oral presentations, including details that develop a central idea. (Core Standard)

3.7.7 Use clear and specific Key Terms to communicate ideas and establish the tone. (Core Standard)

3.7.8 Clarify and enhance oral presentations through the use of appropriate props, including objects, pictures, and charts.

3.7.11 Distinguish between the speaker's opinions and verifiable facts.

3.7.16 Evaluate different evidence (facts, statistics, quotes, testimonials) used to support claims.

3.7.12 Make brief narrative presentations (Core Standard)

#### Grade 4

4.2.7 Follow multiple-step instructions in a basic technical manual.

4.4.5 Quote or paraphrase information sources, citing them appropriately. (Core Standard)

4.4.6 Locate information in reference texts by using organizational features, such as prefaces and appendixes. (Core Standard)

4.4.7 Use multiple reference materials and online information (the Internet) as aids to writing. (Core Standard)

4.7 Students listen critically and respond appropriately to oral communication. They speak in a manner that guides the listener to understand important ideas by using proper phrasing, pitch, and modulation (raising and lowering voice). Students deliver brief oral presentations about familiar experiences or interests that are organized around a coherent thesis statement (a statement of topic). Students use the same Standard English conventions for oral speech that they use in their writing

4.7.2 Summarize major ideas and supporting evidence presented in spoken presentations. (Core Standard)

4.7.4 Give precise directions and instructions.

4.7.5 Present effective introductions and conclusions that guide and inform the listener's understanding of important ideas and details. (Core Standard)

4.7.9 Engage the audience with appropriate words, facial expressions, and gestures.

4.7.16 Distinguish between the speaker's opinions and verifiable facts.

4.7.11 Make narrative presentations (Core Standard)

#### Grade 5

5.2.1 Use the features of informational texts, such as formats, graphics, diagrams, illustrations, charts, maps, and organization, to find information and support understanding. (Core Standard)

5.2.6 Follow multiple-step instructions in a basic technical manual.

5.5.3 Write or deliver a research report that has been developed using a systematic research process (defines the topic, gathers information, determines credibility, reports findings) (Core Standard)



- 5.6 Students write using Standard English conventions appropriate to this grade level.
- 5.7 Students deliver focused, coherent presentations that convey ideas clearly and relate to the background and interests of the audience. They evaluate the content of oral communication. Students deliver well-organized formal presentations using traditional speech strategies, including narration, exposition, persuasion, and description. Students use the same Standard English conventions for oral speech that they use in their writing.

## Mathematics

### Grade 3

- 3.1.1 Count, read, and write whole numbers up to 1000.
- 3.2.7 Use estimation to decide whether answers are reasonable in addition and subtraction problems.
- 3.5.1 Measure line segments to the nearest half-inch.
- 3.5.2 Add units of length that may require regrouping of inches to feet or centimeters to meters.

### Grade 4

- 4.5.1 Measure length to the nearest quarter-inch, eighth-inch, and millimeter.
- 4.7.4 Use a variety of methods, such as words, numbers, symbols, charts, graphs, tables, diagrams, tools, and models to solve problems, justify arguments, and make conjectures.

### Grade 5

- 5.6.1 Explain which types of displays are appropriate for various sets of data.
- 5.6.2 Find the mean, median, mode, and range in a set of data.

## National Science Standards

National Research Council (NRC), 1996

### Grades K–12

Content Standards: Unifying Concepts and Process

- Evidence, Models, and explanations

### Grades K–5

Content Standard A: Science as Inquiry

- Abilities necessary to do scientific inquiry
- Understanding about scientific inquiry

Content Standard B: Physical Science

- Positions and Motion of Objects
- Motions and Forces

Content Standards E: Science and Technology

- Abilities of technological design
- Understanding about science and technology

Content Standard G: History and Nature of Science

- Science as a human endeavor

## National Common Core State Standards

Indiana has adopted the Common Core State Standards for English Language Arts and Mathematics. During the transition period, students in Grades 3–12 will receive an introduction to the Common Core Standards during the 2011–12 school year. In 2014–15, all English language arts and math teachers will only teach the Common Core Standards.

## Language Arts

### Grade 3

#### Reading Standards: Foundation Skills

**RF.3.4** Read with sufficient accuracy and fluency to support comprehension.

#### Reading Standard for Informational Text

**RI.3.1** Ask and answer questions to demonstrate understanding of a text, referring explicitly to the text as the basis for the answers.

**RI.3.2** Determine the main idea of a text; recount the key details and explain how they support the main idea.

**RI.3.3** Describe the relationship between a series of historical events, scientific ideas or concepts, or steps in technical procedures in a text, using language that pertains to time, sequence, and cause/effect.

**RI.3.4** Determine the meaning of general academic and domain-specific words and phrases in a text relevant to a Grade 3 topic or subject area.

**RI.3.5** Use text features and search tools (e.g., key words, sidebars, hyperlinks) to locate information relevant to a given topic efficiently.

## Reading Standards for Literature

**RL.3.1** Ask and answer questions to demonstrate understanding of a text, referring explicitly to the text as the basis for the answers.

## Language Standards

**L.3.4** Determine or clarify the meaning of unknown and multiple-meaning word and phrases based on Grade 3 reading and content, choosing flexibly from a range of strategies.

## Writing Standards

**W.3.2** Write informative/explanatory texts to examine a topic and convey ideas and information clearly.

**W.3.7** Conduct short research projects that build knowledge about a topic.

**W.3.8** Recall information from experiences or gather information from print and digital sources; take brief notes on sources and sort evidence into provided categories.

**Speaking and Listening Standards**

- SL.3.1** Engage effectively in a range of collaborative discussions (one-on-one, in groups, and teacher-led) with diverse partners on Grade 3 topics and texts, building on others' ideas and expressing their own clearly.
- SL.3.2** Determine the main ideas and supporting details of a text read-aloud or information presented in diverse media and formats, including visually, quantitatively, and orally.
- SL.3.3** Ask and answer questions about information from a speaker, offering appropriate elaboration and detail.
- SL.3.4** Report on a topic or text, tell a story, or recount an experience with appropriate facts and relevant, descriptive details, speaking clearly at an understandable pace.
- SL.3.6** Speak in complete sentences when appropriate to task and situation in order to provide requested detail or clarification.

**Grade 4****Reading Standards: Foundation Skills**

- RF.4.4** Read with sufficient accuracy and fluency to support comprehension.

**Reading Standard for Informational Text**

- RI.4.1** Refer to details and examples in a text when explaining what the text says explicitly and when drawing inferences from the text.
- RI.4.2** Determine the main idea of a text and explain how it is supported by key details; summarize the text.
- RI.4.3** Explain events, procedures, ideas, or concepts in a historical, scientific, or technical text, including what happened and why, based on specific information in the text.
- RI.4.4** Determine the meaning of general academic and domain-specific words or phrases in a text relevant to a Grade 4 topic or subject area.

- RI.4.5** Describe the overall structure (e.g., chronology, comparison, cause/effect, problem/solution) of events, ideas, concepts, or information in a text or part of a text.
- RI.4.7** Interpret information presented visually, orally, or quantitatively (e.g., in charts, graphs, diagrams, time lines, animations, or interactive elements on Web pages) and explain how the information contributes to an understanding of the text in which it appears.
- RI.4.10** By the end of year, read and comprehend informational texts, including history/social studies, science, and technical texts, in the Grades 4–5 text complexity band proficiently, with scaffolding as needed at the high end of the range.

**Reading Standards for Literature**

- RI.4.1** Refer to details and examples in a text when explaining what the text says explicitly and when drawing inferences from the text.

**Writing Standards**

- W.4.2** Write informative/explanatory texts to examine a topic and convey ideas and information clearly.
- W.4.7** Conduct short research projects that build knowledge through investigation of different aspects of a topic.
- W.4.8** Recall relevant information from experiences or gather relevant information from print and digital sources.

**Language Standards**

- L.4.4** Determine or clarify the meaning of unknown and multiple-meaning words and phrases based on Grade 4 reading and content, choosing flexibly from a range of strategies.

**Speaking and Listening Standards**

- SL.4.1** Engage effectively in a range of collaborative discussions (one-on-one, in groups, and teacher-led) with diverse partners on Grade 4 topics and texts, building on others' ideas and expressing their own clearly.
- SL.4.2** Paraphrase portions of a text read aloud or information presented in diverse media and formats, including visually, quantitatively, and orally.
- SL.4.4** Report on a topic or text, tell a story, or recount an experience in an organized manner, using appropriate facts and relevant, descriptive details to support main ideas or themes; speak clearly at an understandable pace.

**Grade 5****Reading Standards: Foundation Skills**

- RF.5.4** Read with sufficient accuracy and fluency to support comprehension.

**Reading Standard for Informational Text**

- RI.5.1** Quote accurately from a text when explaining what the text says explicitly and when drawing inferences from the text.
- RI.5.2** Determine two or more main ideas of a text and explain how they are supported by key details; summarize the text.
- RI.5.3** Explain the relationships or interactions between two or more individuals, events, ideas, or concepts in a historical, scientific, or technical text based on specific information in the text.
- RI.5.4** Determine the meaning of general academic and domain-specific words and phrases in a text relevant to a Grade 5 topic or subject area.
- RI.5.7** Draw on information from multiple print or digital sources, demonstrating the ability to locate an answer to a question quickly or to solve a problem efficiently.

**RI.5.9** Integrate information from several texts on the same topic in order to write or speak about the subject knowledgeably.

**RI.5.10** By the end of the year, read and comprehend informational texts, including history/social studies, science, and technical texts, at the high end of the Grades 4–5 text complexity band independently and proficiently.

### Reading Standards for Literature

**RL.5.1** Quote accurately from a text when explaining what the text says explicitly and when drawing inferences from the text.

### Writing Standards

**W.5.2** Write informative/explanatory texts to examine a topic and convey ideas and information clearly.

**5W.7** Conduct short research projects that use several sources to build knowledge through investigation of different aspects of a topic.

**5W.8** Recall relevant information from experiences or gather relevant information from print and digital sources; summarize or paraphrase information in notes and finished work, and provide a list of sources.

**W.5.9** Draw evidence from literary or informational texts to support analysis, reflection, and research.

### Language Standards

**L.5.3** Use knowledge of language and its conventions when writing, speaking, reading, or listening.

**L.5.4** Determine or clarify the meaning of unknown and multiple-meaning words and phrases based on Grade 5 reading and content, choosing flexibly from a range of strategies.

### Speaking and Listening Standards

**SL.5.1** Engage effectively in a range of collaborative discussions (one-on-one, in groups, and teacher-led) with diverse partners on Grade 5 topics and texts, building on others' ideas and expressing their own clearly.

**SL.5.2** Summarize a written text read aloud or information presented in diverse media and formats, including visually, quantitatively, and orally.

**SL.5.3** Summarize the points a speaker makes and explain how each claim is supported by reasons and evidence.

**SL.5.4** Report on a topic or text or present an opinion, sequencing ideas logically and using appropriate facts and relevant, descriptive details to support main ideas or themes; speak clearly at an understandable pace.

**SL.5.5** Include multimedia components (e.g., graphics, sound) and visual displays in presentations when appropriate to enhance the development of main ideas or themes.

### Mathematics

Lessons in this unit of study enable students to apply skills in problem solving, quantitative reasoning, critique, and communication to science investigations. Unit experiences integrate Standards for Mathematical Practice with Standards for Mathematical Content in the area of **Measurement and Data**, including:

#### Grade 3

**MD.3.4** Generate measurement data using rulers marked with halves and fourths of an inch. Show data by making a line plot, where the horizontal scale is marked off in appropriate units.

#### Grade 4

**MD.4.1** Know relative sizes of measurement units within one system of units including km, m, cm; kg, g; lb, oz; l, ml; hr, min, sec. Within a single system of measurement, express measurements in a large unit in smaller units.

#### Grade 5

**MD.5.1** Convert among different-sized measurement units within a given measurement system and use these conversions in solving multi-step, real world problems.



© ALL RIGHTS RESERVED BY THE ACADEMY OF MODEL AERONAUTICS

“I encourage young people who have any interest in aviation at all, or even if you don’t know if you have an interest in aviation, go try model flying.

And the learning, the introduction you’re going to get from models, is going to transfer directly, in my opinion, into flying a full-scale airplane. And it’s just ‘plane’ fun.”

— Robert “Hoot” Gibson

Ambassador, Academy of Model Aeronautics,  
NASA Space Shuttle Commander  
Astronaut Hall of Fame Member  
Naval Aviator